

CFPS2300(2V300Ah)

Specifications

Nominal Voltage		2 V
Capacity (20°C)	10HR(1.80V)	300Ah
	3HR(1.75V)	230 Ah
	1HR(1.60V)	168Ah
Battery Weigh	Dry	18.5kg (40.8lbs) ± 5%
	Wet	24.5kg (54.0lbs) ± 5%
Acid Weight (d=1.24kg/l)		Approx.5kg (11.0lbs)
Terminal type /material		T10 / Copper
Internal resistance (Fully charged, 25°C)		Approx. 0.9 mΩ
Self-discharge	1 month	Remaining Capacity: 86%(20°C)
Nominal operating temperature		20°C±5°C(68°F±9°F)
Operating temperature range	Discharge	-15°C~50°C(5°F~122°F)
	Charge	10°C~45°C(50°F~113°F)
	Storage	10°C~30°C(50°F~86°F)
Initial charging	Constant current	Charge the battery at 0.05 C ₁₀ for 72h.
	Constant voltage	Charge the battery at 0.1 C ₁₀ to 2.35v/cell; then Charge the battery with 2.35v/cell until the whole charge time up to 100h.
Mark of Fully charged	Constant current	The battery voltage and density of electrolyte remain stable over 2h at the end of charging , and strong bubbles generated within the electrolyte
	Constant voltage	The charging current and density of electrolyte kept constant for more than 3h at the end of the charge; and the charging current is about 0.002~0.005 C ₁₀ amp.
Supplementary charge		Charge the battery at 0.05 C ₁₀ to fully charged.
Equalizing charging		Charge the battery with 2.40v/cell for 48h.
Battery operation	Float charging	Charge the battery with 2.23V (25°C); Equalizing charging the battery when the abnormal occurs
	Charge& discharge	Equalizing charging the battery after discharged and per 3months
	Backup	Supplementary charge the battery per 3 or 6 months.
Maximum charging current		75.0A(0.25C ₁₀)
Max. discharge current		1500A(5 sec.)
Designed cycle life		1600@80% DOD (30°C)
Designed floating life		20 years(20°C)

CHARACTERISTICS:

- ◆ Tubular Positive Plate;
- ◆ Flooded Battery;
- ◆ Porous Rubber and Porous PVC Separator
- ◆ Transparent Container.

Dimensions

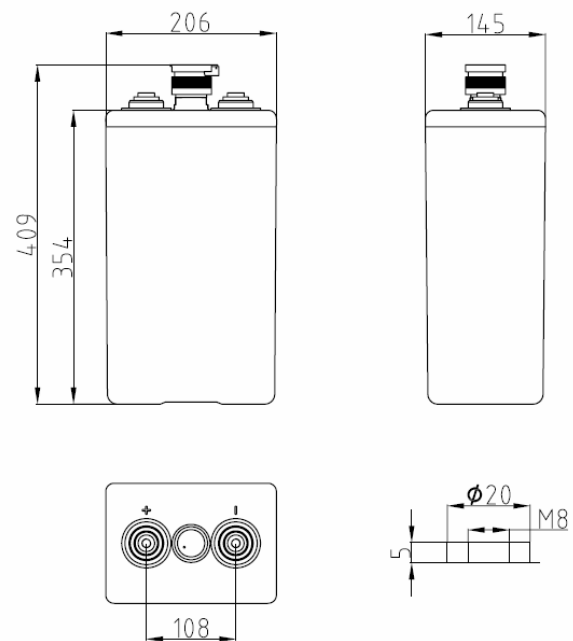

Constant Current Discharge Characteristics (A, 25°C)

F.V/TIME	30min	60min	2h	3h	4h	5h	6h	8h	10h	20h	24h	48h	120h
1.70V	234	162	99.0	77.1	61.8	54.3	46.2	35.4	30.3	16.4	14.3	----	----
1.75V	228	158	97.5	76.5	61.5	54.0	45.9	35.1	30.3	16.4	14.2	----	----
1.80V	220	153	95.1	74.1	59.7	52.5	44.4	33.9	30.0	16.2	14.1	7.23	----
1.85V	208	144	89.4	69.6	56.1	49.5	41.7	31.8	28.5	15.5	13.4	7.23	3.00

Constant Power Discharge Characteristics (Watt, 25°C)

F.V/TIME	30min	60min	2h	3h	4h	5h	6h	8h	10h	20h	24h	48h	120h
1.70V	437	306	191	152	122	107	91.2	69.9	60.6	32.7	28.7	----	----
1.75V	426	300	188	150	121	107	90.3	69.6	60.0	32.7	28.5	----	----
1.80V	412	291	183	146	117	103	87.6	67.5	59.7	32.4	28.4	14.7	----
1.85V	383	270	171	135	109	96.0	81.6	62.7	55.5	30.0	27.0	14.7	6.12

Note: The above characteristics data can be obtained within three charge/discharge cycles.

Discharge Characteristics(25°C)

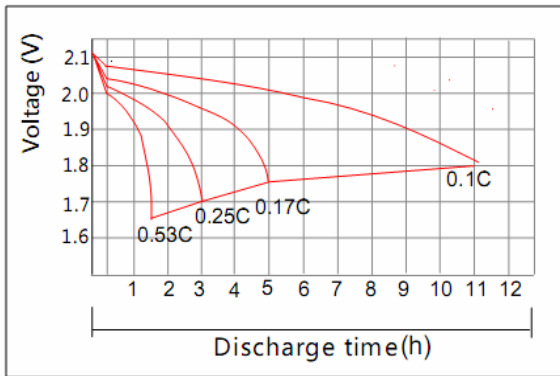

Initial Charging (CC) Characteristics(25°C)

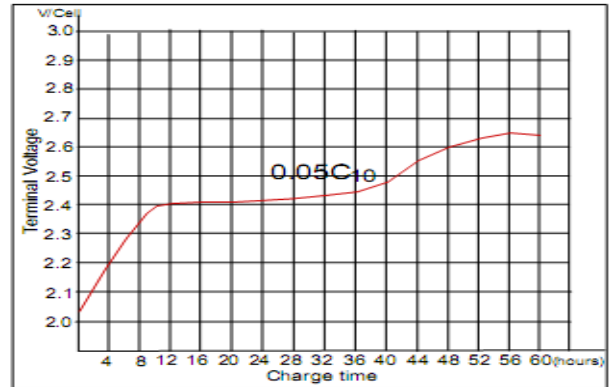

Effect of Temperature on Capacity

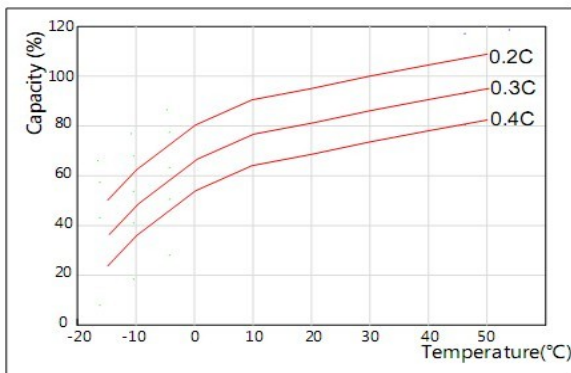

Initial Charging (CV) Characteristics

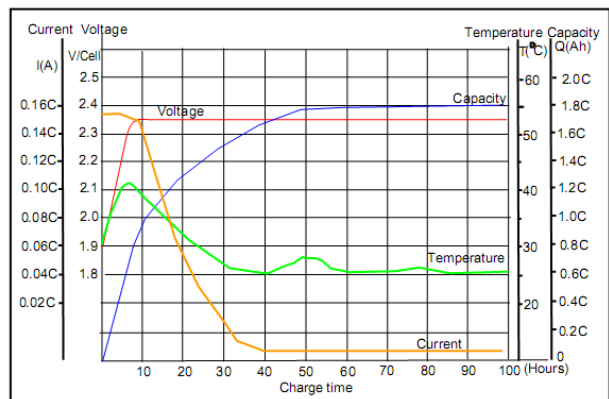

The Relationship for Open Circuit Voltage and Residual Capacity (25°C)

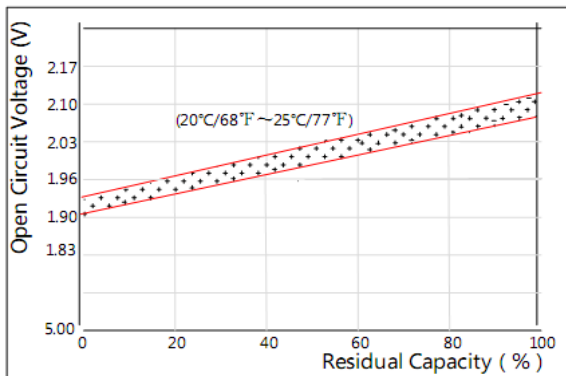

Supplementary charge (CV) Characteristics

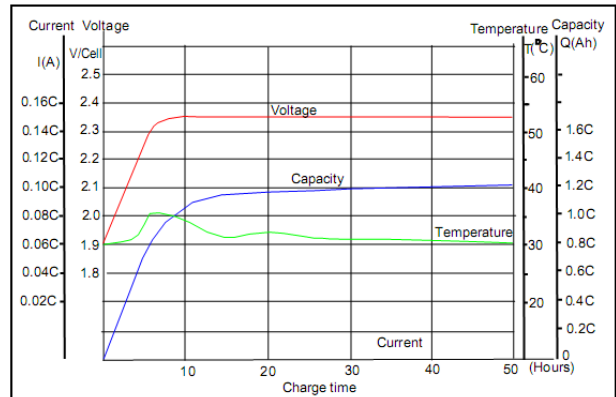

Effect of Discharge rate on Capacity

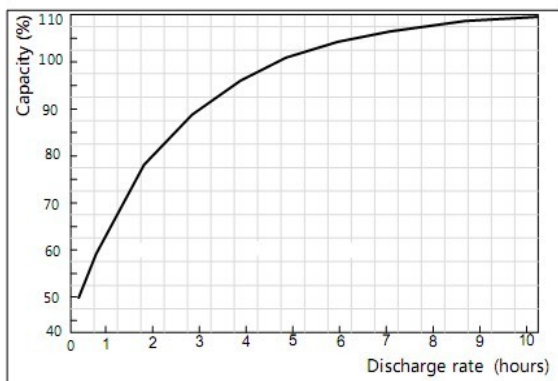

Cycle Life on D.O.D(25°C)

