

Specifications

Nominal Voltage		2 V
Capacity (25°C)	120HR(1.80V)	425Ah
	10HR(1.80V)	350 Ah
	1HR(1.60V)	196Ah
Dimension	Length	124 ± 2mm (4.88inch)
	Width	206 ± 2mm (8.11inch)
	Height	470 ± 3mm (18.5inch)
	Total Height	506 ± 3mm (19.9inch)
Approx. Weight		26.5kg (58.3lbs) ± 4%
Terminal type		T10
Internal resistance (Fully charged, 25°C)		Approx.0.80 m Ω
Capacity affected by temperature (10HR)	40°C	103%
	25°C	100%
	0°C	88%
	-15°C	70%
Self-discharge (25°C)	3 month	Remaining Capacity: 94%
	6 month	Remaining Capacity: 88%
	12 month	Remaining Capacity: 75%
Nominal operating temperature		25°C ± 3°C(77°F ± 5°F)
Operating temperature range	Discharge	-15°C ~ 50°C(5°F ~ 122°F)
	Charge	-10°C ~ 50°C(14°F ~ 122°F)
	Storage	-20°C ~ 50°C(-4°F ~ 122°F)
Float charging voltage(25°C)		2.25 to 2.27V Temperature compensation: -3mV/°C
Cyclic charging voltage(25°C)		2.35 to 2.40V Temperature compensation: -4mV/°C
Maximum charging current		70A
Terminal material		Copper
Maximum discharge current		1750A(5 sec.)
Designed floating life(20°C)		20 years

- ◆ Gelled electrolyte technology;
- ◆ Tubular Positive Plate;
- ◆ ABS container.
- ◆ DIN 40742 Standard.

Constant Current Discharge Characteristics (A, 25°C)

F.V/TIME	30min	60min	2h	3h	4h	5h	6h	8h	10h	20h	24h	48h	72h	100h	120h
1.65V	292	193	120	92.4	74.6	63.7	54.6	43.1	35.7	18.8	16.2	---	---	---	---
1.70V	283	191	119	91.7	73.9	63.0	54.3	42.7	35.4	18.8	16.1	8.58	---	---	---
1.75V	276	188	117	91.0	73.5	62.7	53.9	42.4	35.4	18.7	16.1	8.54	5.81	---	---
1.80V	266	182	114	88.2	71.4	60.9	52.2	41.0	35.0	18.6	16.0	8.47	5.78	---	---
1.85V	252	173	109	83.7	67.9	57.8	49.7	38.9	33.3	17.6	15.2	8.30	5.67	4.24	3.55

Constant Power Discharge Characteristics (Watt, 25°C)

F.V/TIME	30min	60min	2h	3h	4h	5h	6h	8h	10h	20h	24h	48h	72h	100h	120h
1.65V	545	373	232	181	146	125	108	85.1	70.7	37.8	32.7	---	---	---	---
1.70V	529	364	230	180	145	124	107	84.4	70.7	37.5	32.4	17.3	---	---	---
1.75V	516	357	226	179	144	124	106	84.0	70.0	37.5	32.3	17.2	11.9	---	---
1.80V	497	346	221	173	140	120	103	81.2	69.7	37.1	32.2	17.1	11.8	---	---
1.85V	472	329	210	164	133	114	98	77.0	66.2	35.2	30.6	16.8	11.6	8.54	7.28

Note: The above characteristics data can be obtained within three charge/discharge cycles.

Dimensions

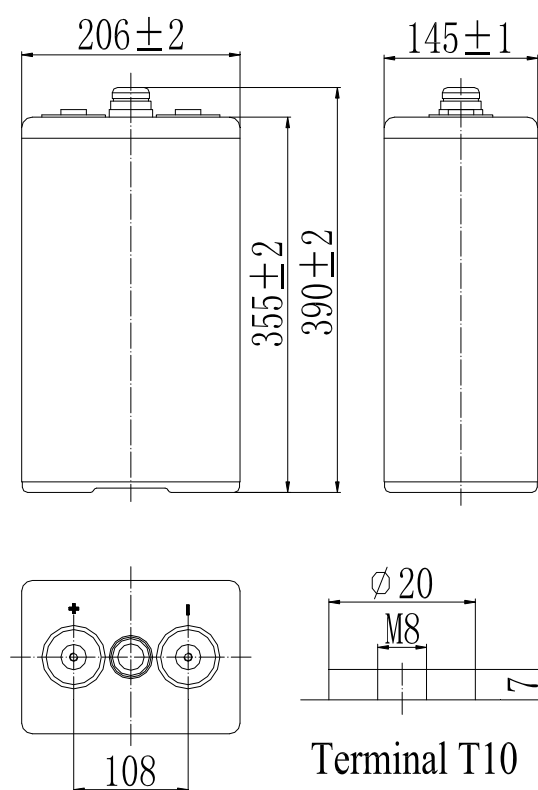

CFPV2350(2V350Ah)

Discharge Characteristics(25°C)

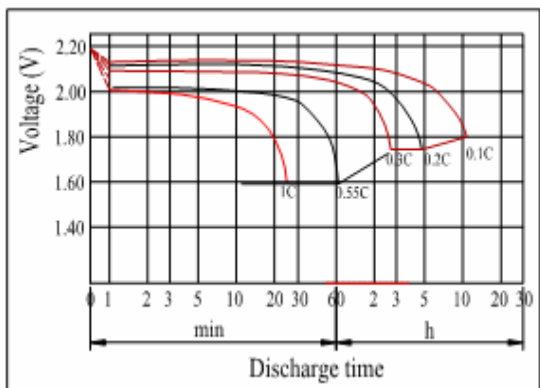

Charging Characteristics(25°C)

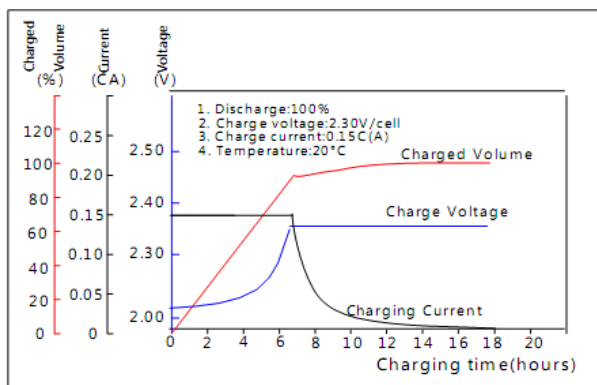

Effect of Temperature on Capacity

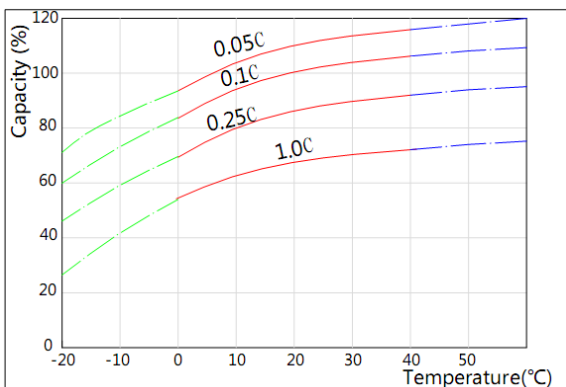

Self-discharge Characteristics

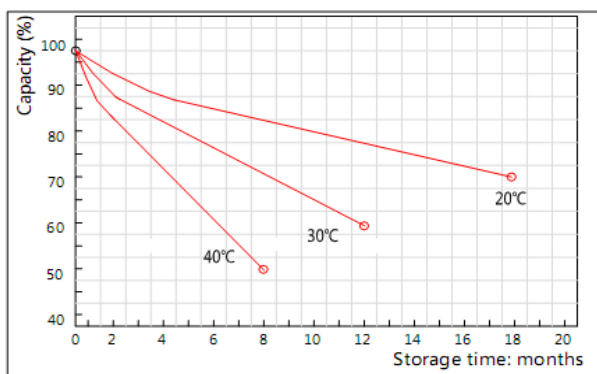

The Relationship for Open Circuit Voltage and Residual Capacity (25°C)

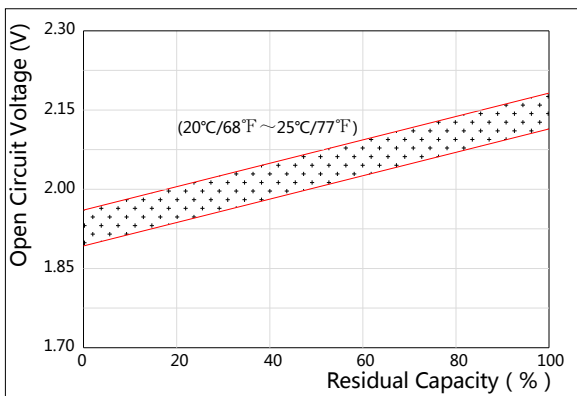

The Relationship for Charging Voltage and Temperature

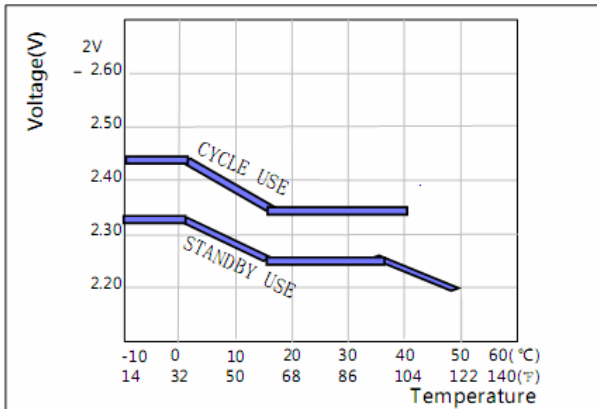

Floating Life on Temperature

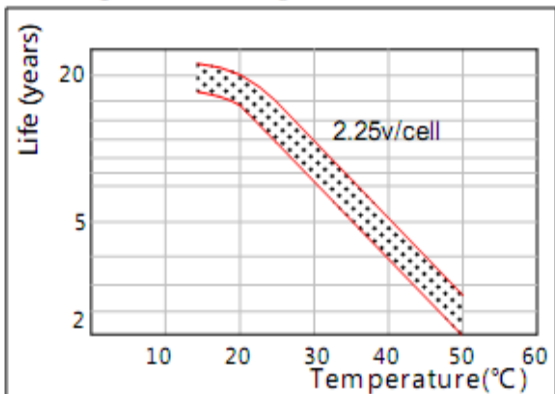

Cycle Life on D.O.D(25°C)

