

LFPG12140 (12V140Ah)

Specifications

Nominal Voltage		12 V
Capacity (25°C)	20HR(10.5V)	140Ah
	5HR(10.2V)	109 Ah
	1HR(9.6V)	81.5 Ah
Dimension	Length	342 ± 2mm (13.46inch)
	Width	172 ± 2mm (6.77inch)
	Height	280 ± 2mm (11.02inch)
	Total Height	285 ± 2mm (11.22inch)
Approx. Weight		42.5kg (93.5lbs) ± 4%
Terminal type		T11
Internal resistance (Fully charged, 25°C)		Approx. 4.2m Ω
Capacity affected by temperature (10HR)	40°C	103%
	25°C	100%
	0°C	88%
	-15°C	70%
Self-discharge (25°C)	3 month	Remaining Capacity: 94%
	6 month	Remaining Capacity: 88%
	12 month	Remaining Capacity: 75%
Nominal operating temperature		25°C ± 3°C (77°F ± 5°F)
Operating temperature range	Discharge	-15°C ~ 55°C (5°F ~ 131°F)
	Charge	-10°C ~ 55°C (14°F ~ 131°F)
	Storage	-20°C ~ 55°C (-4°F ~ 131°F)
Float charging voltage(25°C)		13.50 to 13.80V Temperature compensation: -18mV/°C
Cyclic charging voltage(25°C)		14.10 to 14.40V Temperature compensation: -30mV/°C
Maximum charging current		28A
Terminal material		Copper
Maximum discharge current		1340A(5 sec.)
Designed floating life(20°C)		15 years

- ◆ Gelled electrolyte technology;
- ◆ PVC separator;
- ◆ Recognized by UL & CE;
- ◆ ABS container.

Constant Current Discharge Characteristics (A, 25°C)

F.V/TIME	15min	30min	60min	2h	3h	4h	5h	6h	8h	10h	20h	48h	120h
9.60V	189	131	81.5	47.6	33.6	26.4	22.1	18.9	14.7	13.1	7.16	---	---
9.90V	185	128	80.3	47.3	33.3	26.2	22.0	18.8	14.7	13.1	7.14	---	---
10.2V	177	124	78.2	46.9	33.1	26.0	21.8	18.6	14.6	13.0	7.12	3.12	---
10.5V	172	121	76.6	46.2	32.9	25.9	21.7	18.5	14.5	13.0	7.00	3.10	1.40
10.8V	162	117	74.3	45.0	31.9	25.1	21.1	17.9	14.0	12.9	7.03	3.10	1.40

Constant Power Discharge Characteristics (Watt, 25°C)

F.V/TIME	15min	30min	60min	2h	3h	4h	5h	6h	8h	10h	20h	48h	120h
9.60V	2109	1488	939	554	397	313	263	224	175	158	86.2	---	---
9.90V	2059	1458	925	551	394	311	261	223	175	157	86.1	---	---
10.2V	1982	1413	901	546	392	308	259	221	174	157	85.9	37.4	---
10.5V	1915	1379	883	538	389	306	258	219	172	156	84.4	37.1	15.5
10.8V	1814	1328	856	525	377	297	250	213	167	155	84.7	37.1	15.4

Note: The above characteristics data can be obtained within three charge/discharge cycles.

Dimensions

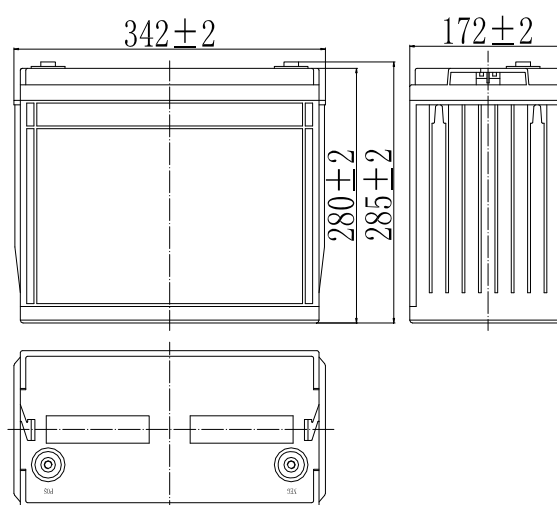

Terminal

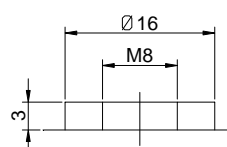

Terminal T11

LFPG12140 (12V140Ah)

Discharge Characteristics(25°C)

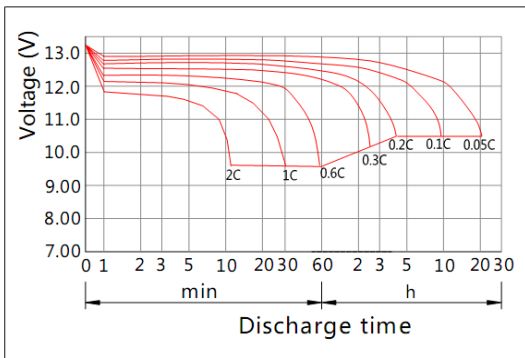

Charging Characteristics(25°C)

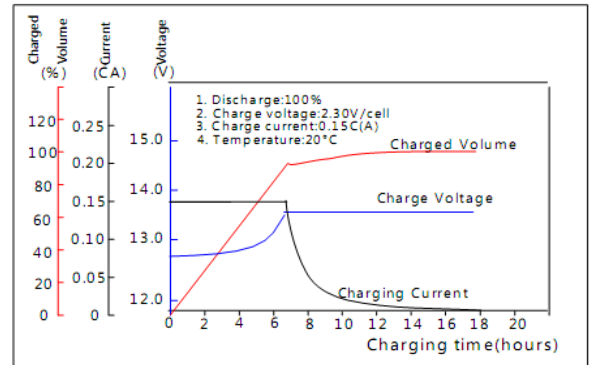

Effect of Temperature on Capacity

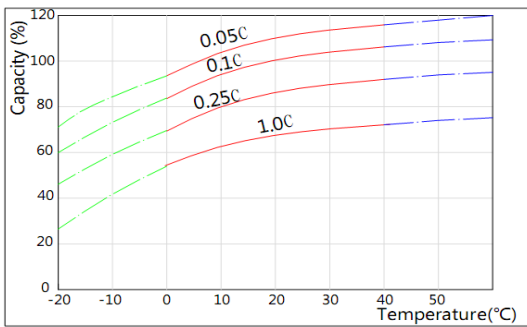

Self-discharge Characteristics

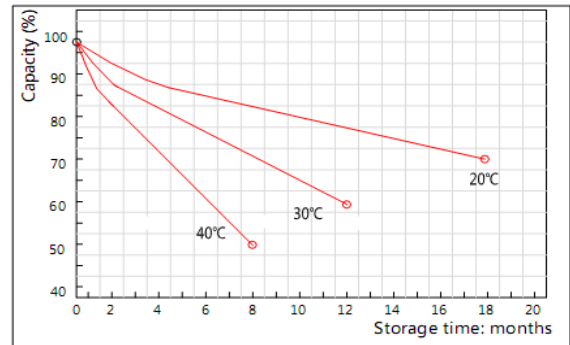

The Relationship for Open Circuit Voltage and Residual Capacity (25°C)

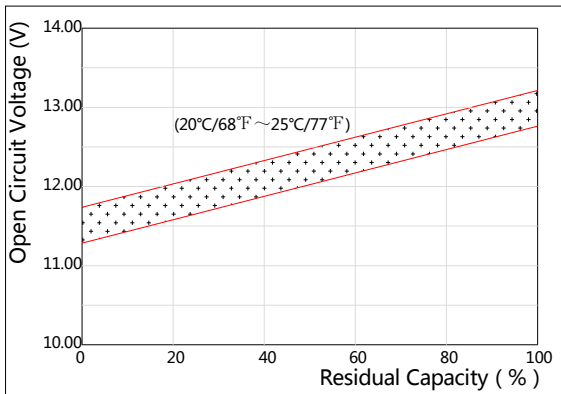

The Relationship for Charging Voltage and Temperature

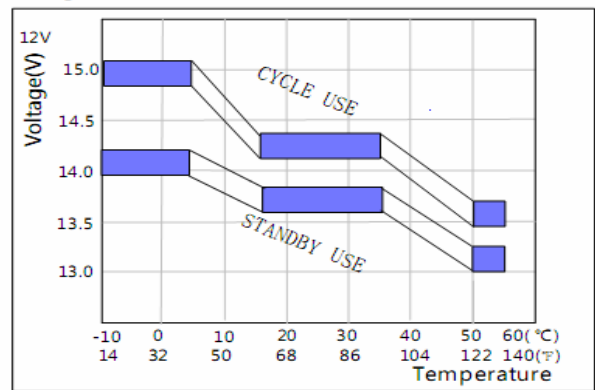

Floating Life on Temperature

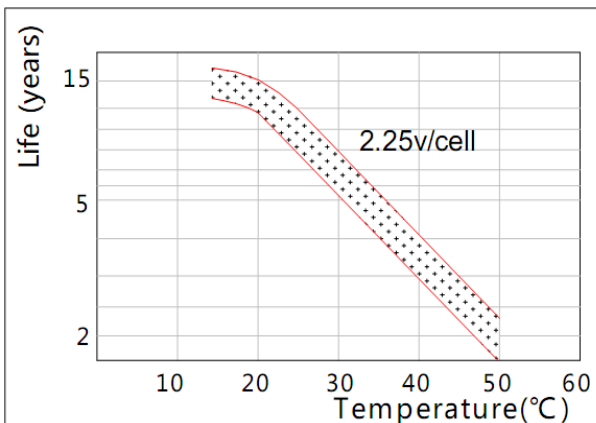

Cycle Life on D.O.D(25°C)

