

LFP1250FT(12V50Ah)

Specifications

Nominal Voltage		12 V
Capacity (25°C)	10HR(10.8V)	50 Ah
	5HR(10.5V)	43.5Ah
	1HR(9.60V)	31Ah
Dimension	Length	277 ± 2mm (10.91inch)
	Width	106 ± 2mm (4.17inch)
	Height	221 ± 2mm (8.70inch)
	Total Height	221 ± 2mm (8.70inch)
Approx. Weight		17kg (37.4lbs) ± 4%
Terminal type		T9
Internal resistance (Fully charged, 25°C)		Approx. 7.5m Ω
Capacity affected by temperature (10HR)	40°C	102%
	25°C	100%
	0°C	85%
	-15°C	65%
Self-discharge (25°C)	3 month	Remaining Capacity: 91%
	6 month	Remaining Capacity: 82%
	12 month	Remaining Capacity: 65%
Nominal operating temperature		25°C ± 3°C (77°F ± 5°F)
Operating temperature range	Discharge	-15°C ~ 50°C (5°F ~ 122°F)
	Charge	-10°C ~ 50°C (14°F ~ 122°F)
	Storage	-20°C ~ 50°C (-4°F ~ 122°F)
Float charging voltage(25°C)		13.50 to 13.80V Temperature compensation: -18mV/°C
Cyclic charging voltage(25°C)		14.50 to 14.90V Temperature compensation: -30mV/°C
Maximum charging current		15A
Terminal material		Copper
Maximum discharge current		500A(5 sec.)
Designed floating life(20°C)		15 years



Dimensions

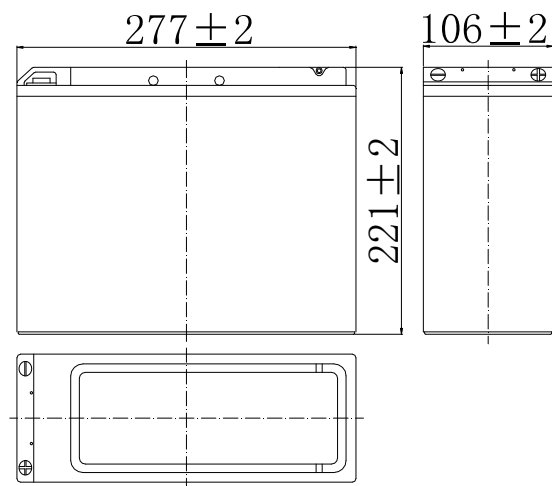

Terminal

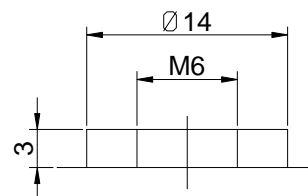

Terminal T9

- ◆ Absorbent glass mat technology;
- ◆ Recognized by UL & CE;
- ◆ ABS container.

Constant Current Discharge Characteristics (A, 25°C)

F.V/TIME	15min	30min	60min	2h	3h	4h	5h	6h	8h	10h	20h
9.60V	80.9	49.0	31.0	18.3	12.8	10.5	8.93	7.80	6.12	5.09	2.67
9.90V	78.9	48.0	30.5	18.2	12.7	10.4	8.87	7.76	6.08	5.08	2.67
10.2V	76.0	46.6	29.8	18.0	12.6	10.3	8.81	7.70	6.04	5.07	2.66
10.5V	73.4	45.4	29.2	17.7	12.5	10.3	8.75	7.65	6.00	5.04	2.64
10.8V	69.5	43.8	28.3	17.3	12.1	9.94	8.49	7.42	5.82	5.00	2.63

Constant Power Discharge Characteristics (Watt, 25°C)

F.V/TIME	15min	30min	60min	2h	3h	4h	5h	6h	8h	10h	20h
9.60V	888	550	353	212	150	123	105	92.2	72.7	60.8	32.1
9.90V	866	539	348	210	149	122	105	91.7	72.3	60.7	32.0
10.2V	834	522	339	208	148	121	104	91.1	71.8	60.5	31.9
10.5V	806	510	333	205	147	121	103	90.4	71.3	60.1	31.7
10.8V	763	491	322	200	143	117	100	87.7	69.1	59.7	31.5

Note: The above characteristics data can be obtained within three charge/discharge cycles.

LFP1250FT(12V50Ah)

Discharge Characteristics(25°C)

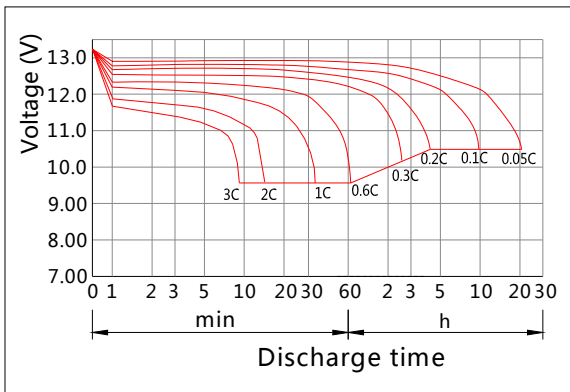

Charging Characteristics(25°C)

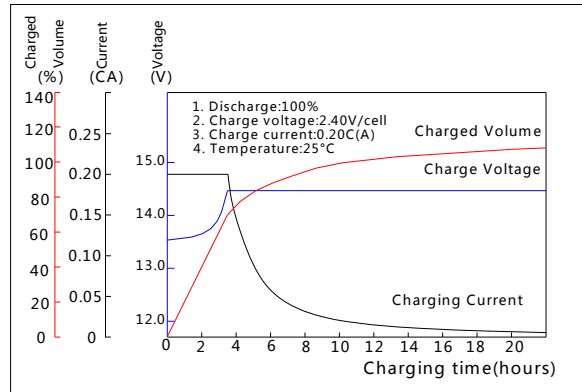

Effect of Temperature on Capacity

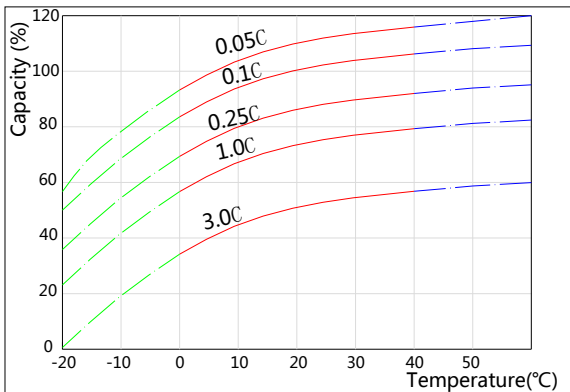

Self-discharge Characteristics

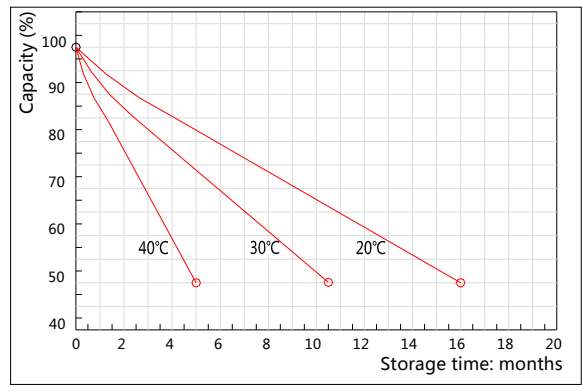

The Relationship for Open Circuit Voltage and Residual Capacity (25°C)

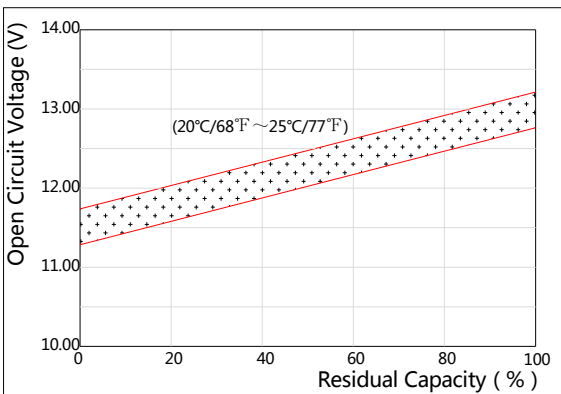

The Relationship for Charging Voltage and Temperature

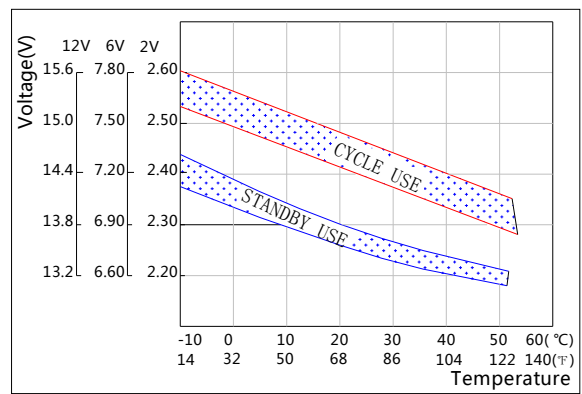

Floating Life on Temperature

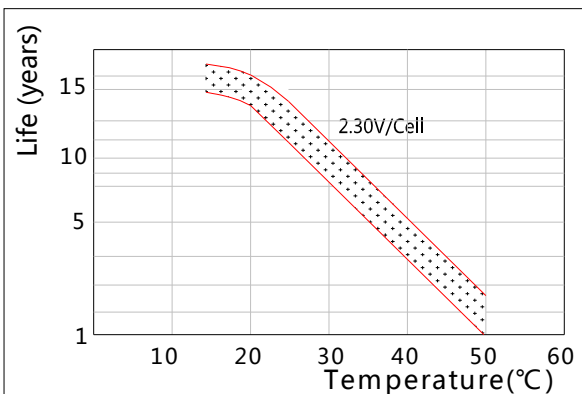

Cycle Life on D.O.D(25°C)

