

LFP1255FT(12V55Ah)

Specifications

Nominal Voltage		12 V
Capacity (25°C)	10HR(10.8V)	55 Ah
	5HR(10.5V)	48Ah
	1HR(9.60V)	34Ah
Dimension	Length	277±2mm (10.91inch)
	Width	106±2mm (4.17inch)
	Height	221±2mm (8.70inch)
	Total Height	221±2mm (8.70inch)
Approx. Weight		17.5kg (38.5lbs)±4%
Terminal type		T9
Internal resistance (Fully charged, 25°C)		Approx. 6.5mΩ
Capacity affected by temperature (10HR)	40°C	102%
	25°C	100%
	0°C	85%
	-15°C	65%
Self-discharge (25°C)	3 month	Remaining Capacity: 91%
	6 month	Remaining Capacity: 82%
	12 month	Remaining Capacity: 65%
Nominal operating temperature		25°C ± 3°C (77°F ± 5°F)
Operating temperature range	Discharge	-15°C ~ 50°C (5°F ~ 122°F)
	Charge	-10°C ~ 50°C (14°F ~ 122°F)
	Storage	-20°C ~ 50°C (-4°F ~ 122°F)
Float charging voltage(25°C)		13.50 to 13.80V Temperature compensation: -18mV/°C
Cyclic charging voltage(25°C)		14.50 to 14.90V Temperature compensation: -30mV/°C
Maximum charging current		17.5A
Terminal material		Copper
Maximum discharge current		500A(5 sec.)
Designed floating life(20°C)		15 years



Dimensions

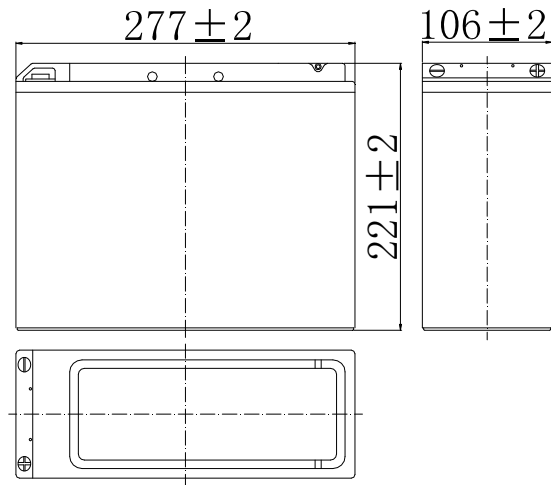

Terminal

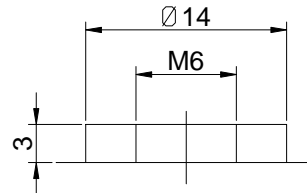

Terminal T9

- ◆ Absorbent glass mat technology;
- ◆ Recognized by UL & CE;
- ◆ ABS container.

Constant Current Discharge Characteristics (A, 25°C)

F.V/TIME	15min	30min	60min	2h	3h	4h	5h	6h	8h	10h	20h
9.60V	88.9	53.9	34.1	20.1	14.0	11.5	9.82	8.58	6.73	5.60	2.94
9.90V	86.8	52.8	33.6	20.0	13.9	11.4	9.76	8.53	6.69	5.59	2.93
10.2V	83.6	51.2	32.7	19.8	13.8	11.4	9.69	8.47	6.65	5.57	2.93
10.5V	80.8	50.0	32.1	19.5	13.8	11.3	9.63	8.42	6.60	5.54	2.91
10.8V	76.5	48.1	31.1	19.0	13.3	10.9	9.34	8.16	6.40	5.50	2.89

Constant Power Discharge Characteristics (Watt, 25°C)

F.V/TIME	15min	30min	60min	2h	3h	4h	5h	6h	8h	10h	20h
9.60V	977	605	389	233	165	135	116	101	80.0	66.9	35.3
9.90V	953	593	383	231	164	134	115	101	79.5	66.7	35.2
10.2V	918	575	373	229	163	134	115	100	79.0	66.5	35.1
10.5V	887	561	366	226	162	133	114	99.5	78.4	66.1	34.9
10.8V	840	540	355	220	157	129	110	96.5	76.1	65.7	34.7

Note: The above characteristics data can be obtained within three charge/discharge cycles.

LFP1255FT(12V55Ah)

Discharge Characteristics(25°C)

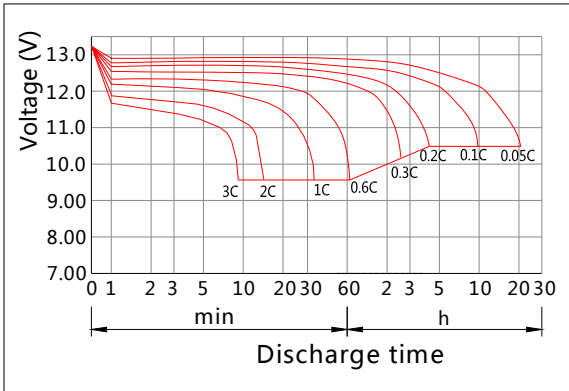

Charging Characteristics(25°C)

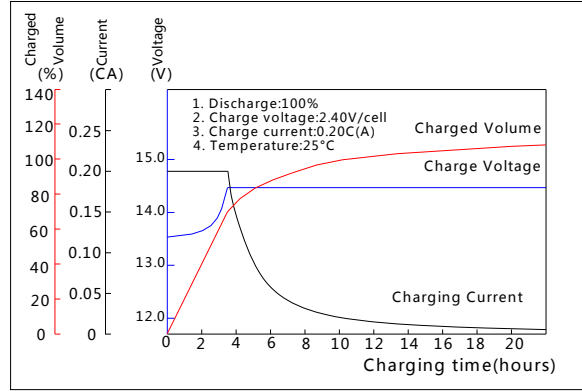

Effect of Temperature on Capacity

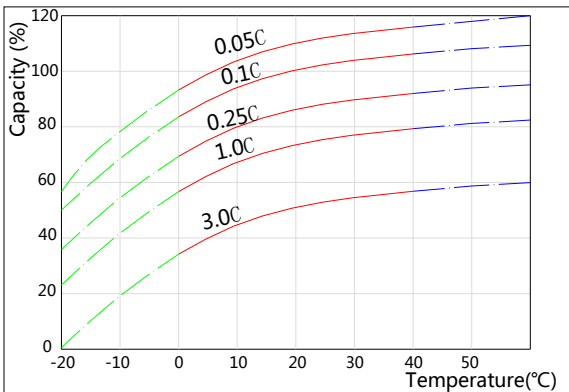

Self-discharge Characteristics

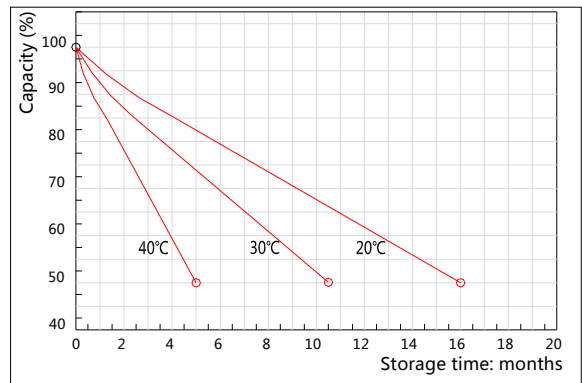

The Relationship for Open Circuit Voltage and Residual Capacity (25°C)

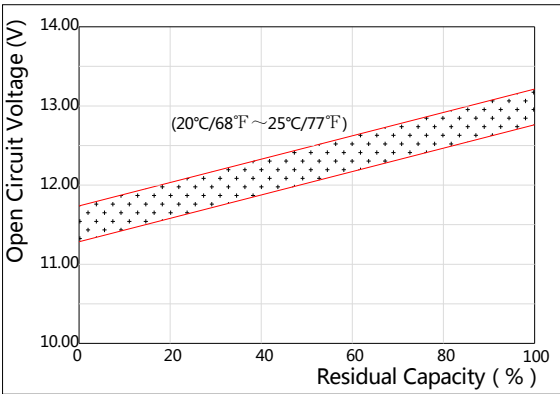

The Relationship for Charging Voltage and Temperature

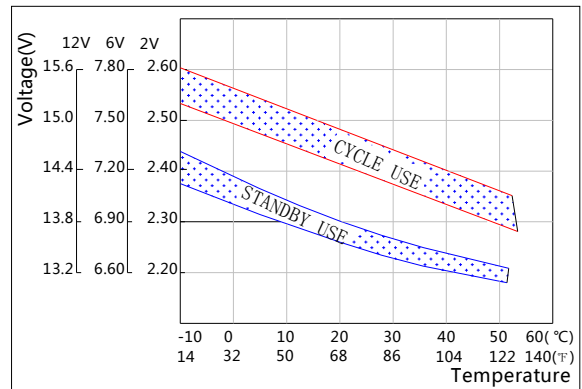

Floating Life on Temperature

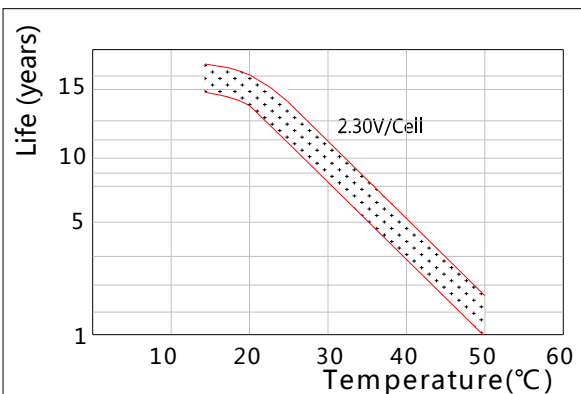

Cycle Life on D.O.D(25°C)

