

Specifications

Nominal Voltage		12 V
Capacity (25°C)	10HR(10.8V)	65 Ah
	5HR(10.5V)	57Ah
	1HR(9.60V)	40.3Ah
Dimension	Length	350±2mm (13.78inch)
	Width	167±2mm (6.57inch)
	Height	179±2mm (7.05inch)
	Total Height	T5: 186±2mm (7.32inch) T9: 179±2mm (7.05inch)
Approx. Weight		22.5kg (49.6lbs)±4%
Terminal type		T5/T9
Internal resistance (Fully charged, 25°C)		Approx. 6mΩ
Capacity affected by temperature (10HR)	40°C	102%
	25°C	100%
	0°C	85%
	-15°C	65%
Self-discharge (25°C)	3 month	Remaining Capacity: 91%
	6 month	Remaining Capacity: 82%
	12 month	Remaining Capacity: 65%
Nominal operating temperature		25°C ± 3°C (77°F ± 5°F)
Operating temperature range	Discharge	-15°C ~ 50°C (5°F ~ 122°F)
	Charge	-10°C ~ 50°C (14°F ~ 122°F)
	Storage	-20°C ~ 50°C (-4°F ~ 122°F)
Float charging voltage(25°C)		13.50 to 13.80V Temperature compensation: -18mV/°C
Cyclic charging voltage(25°C)		14.50 to 14.90V Temperature compensation: -30mV/°C
Maximum charging current		19.5A
Terminal material		Copper
Maximum discharge current		650A(5 sec.)
Designed floating life(20°C)		15 years

- ◆ Absorbent glass mat technology;
- ◆ Recognized by UL & CE;
- ◆ ABS container.

Constant Current Discharge Characteristics (A, 25°C)

F.V/TIME	10min	15min	30min	60min	2h	3h	4h	5h	8h	10h	20h
9.60V	132	105	63.7	40.3	23.8	16.6	13.6	11.6	7.96	6.62	3.47
9.90V	128	103	62.4	39.7	23.6	16.5	13.5	11.5	7.91	6.60	3.47
10.2V	123	98.8	60.5	38.7	23.4	16.4	13.4	11.5	7.85	6.58	3.46
10.5V	118	95.4	59.0	37.9	23.0	16.3	13.3	11.4	7.80	6.55	3.44
10.8V	111	90.4	56.9	36.8	22.5	15.8	12.9	11.0	7.57	6.50	3.41

Constant Power Discharge Characteristics (Watt, 25°C)

F.V/TIME	10min	15min	30min	60min	2h	3h	4h	5h	8h	10h	20h
9.60V	1430	1154	715	459	275	195	160	137	94.5	79.0	41.7
9.90V	1387	1126	700	453	273	194	159	136	94.0	78.9	41.6
10.2V	1330	1085	679	441	271	192	158	135	93.3	78.6	41.5
10.5V	1273	1048	663	432	267	191	157	134	92.7	78.2	41.2
10.8V	1201	992	638	419	260	185	152	130	89.9	77.6	41.0

Note: The above characteristics data can be obtained within three charge/discharge cycles.

Dimensions

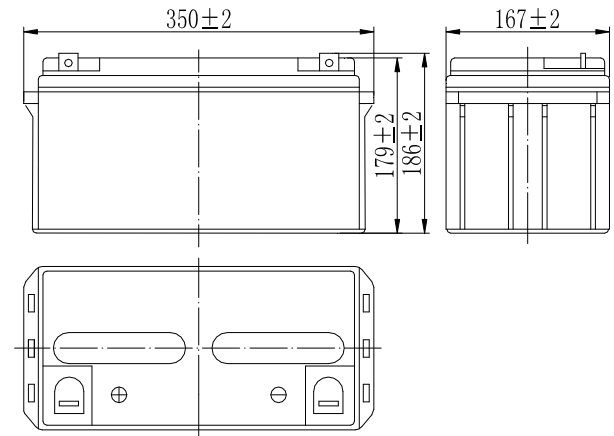

Terminal

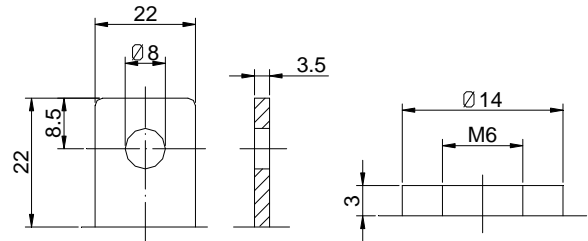

Terminal T5

Terminal T9

LFP1265L(12V65Ah)

Discharge Characteristics(25°C)

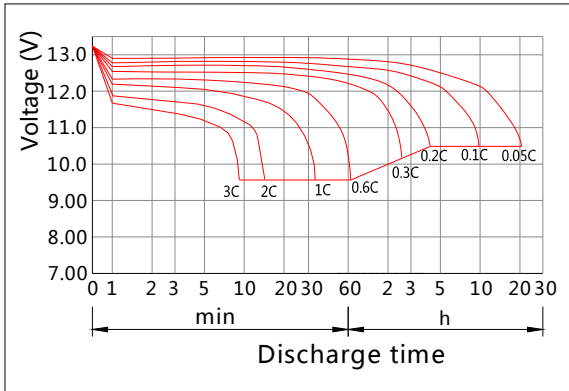

Charging Characteristics(25°C)

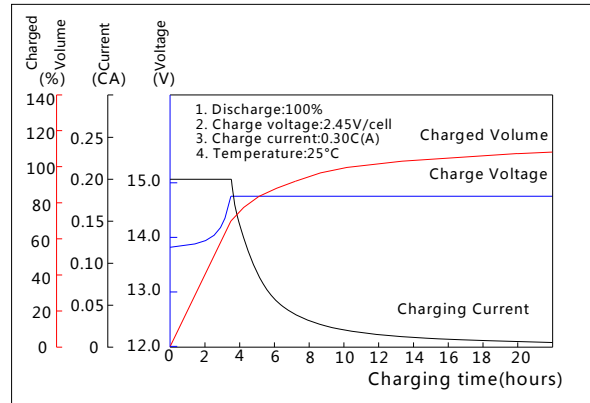

Effect of Temperature on Capacity

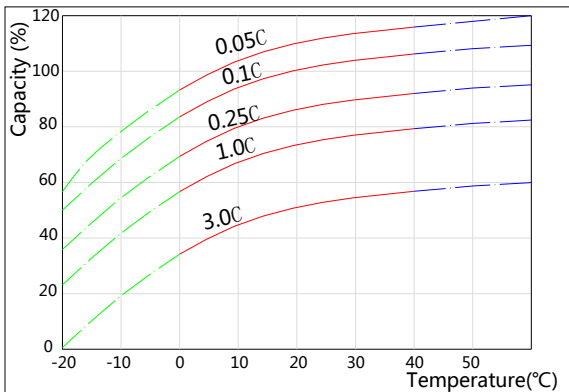

Self-discharge Characteristics

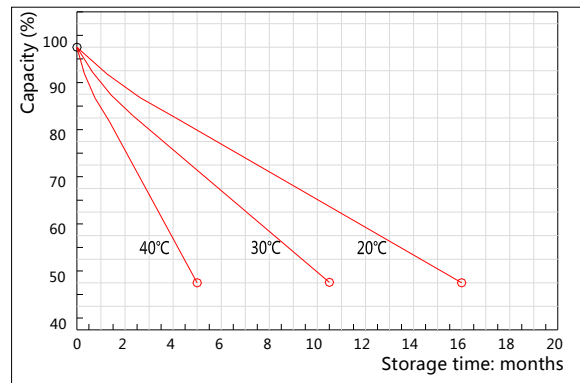

The Relationship for Open Circuit Voltage and Residual Capacity (25°C)

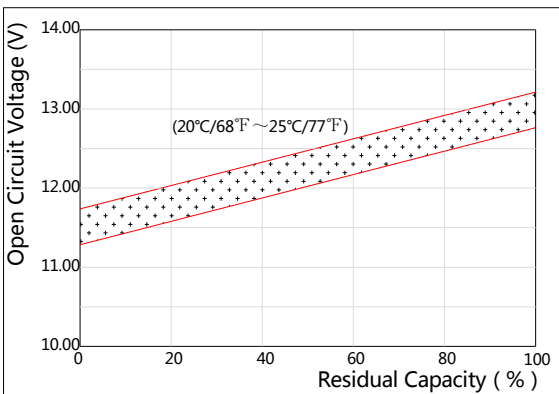

The Relationship for Charging Voltage and Temperature

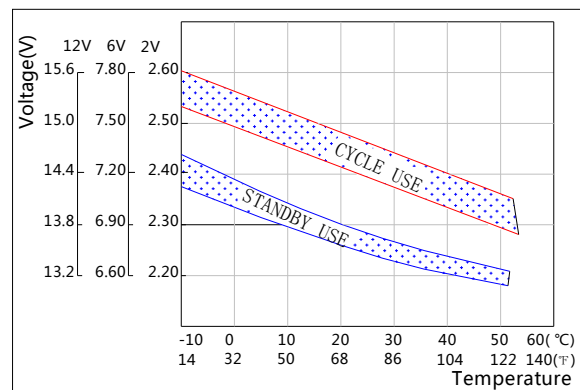

Floating Life on Temperature

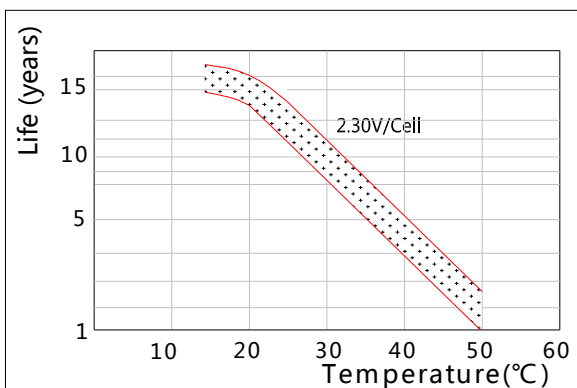

Cycle Life on D.O.D(25°C)

