

LFP12120FT(12V120Ah)

Specifications

Nominal Voltage		12 V
Capacity (25°C)	10HR(10.8V)	120 Ah
	5HR(10.5V)	105Ah
	1HR(9.60V)	74Ah
Dimension	Length	551 ± 3mm (21.69inch)
	Width	110 ± 2mm (4.33inch)
	Height	239 ± 2mm (9.41inch)
	Total Height	239 ± 2mm (9.41inch)
Approx. Weight		36kg (79.4lbs) ± 4%
Terminal type		T11
Internal resistance (Fully charged, 25°C)		Approx. 4.3m Ω
Capacity affected by temperature (10HR)	40°C	102%
	25°C	100%
	0°C	85%
	-15°C	65%
Self-discharge (25°C)	3 month	Remaining Capacity: 91%
	6 month	Remaining Capacity: 82%
	12 month	Remaining Capacity: 65%
Nominal operating temperature		25°C ± 3°C (77°F ± 5°F)
Operating temperature range	Discharge	-15°C ~ 50°C (5°F ~ 122°F)
	Charge	-10°C ~ 50°C (14°F ~ 122°F)
	Storage	-20°C ~ 50°C (-4°F ~ 122°F)
Float charging voltage(25°C)		13.50 to 13.80V Temperature compensation: -18mV/°C
Cyclic charging voltage(25°C)		14.50 to 14.90V Temperature compensation: -30mV/°C
Maximum charging current		36A
Terminal material		Copper
Maximum discharge current		960A(5 sec.)
Designed floating life(20°C)		15 years

- ◆ Absorbent glass mat technology;
- ◆ Recognized by UL & CE;
- ◆ ABS container.

Constant Current Discharge Characteristics (A, 25°C)

F.V/TIME	15min	30min	60min	2h	3h	4h	5h	6h	8h	10h	20h
9.60V	194	118	74.4	43.8	30.6	25.1	21.4	18.7	14.7	12.2	6.41
9.90V	189	115	73.3	43.6	30.4	24.9	21.3	18.6	14.6	12.2	6.40
10.2V	182	112	71.4	43.2	30.2	24.8	21.1	18.5	14.5	12.2	6.38
10.5V	176	109	70.0	42.6	30.0	24.6	21.0	18.4	14.4	12.1	6.34
10.8V	167	105	67.9	41.5	29.1	23.9	20.4	17.8	14.0	12.0	6.30

Constant Power Discharge Characteristics (Watt, 25°C)

F.V/TIME	15min	30min	60min	2h	3h	4h	5h	6h	8h	10h	20h
9.60V	2131	1319	848	508	360	295	253	221	174	146	77.0
9.90V	2079	1293	835	505	358	293	252	220	173	146	76.8
10.2V	2003	1253	814	500	355	291	250	219	172	145	76.6
10.5V	1935	1223	798	493	353	289	248	217	171	144	76.1
10.8V	1832	1178	774	480	342	281	241	211	166	143	75.6

Note: The above characteristics data can be obtained within three charge/discharge cycles.

Dimensions

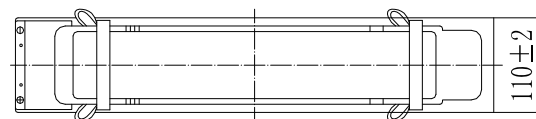
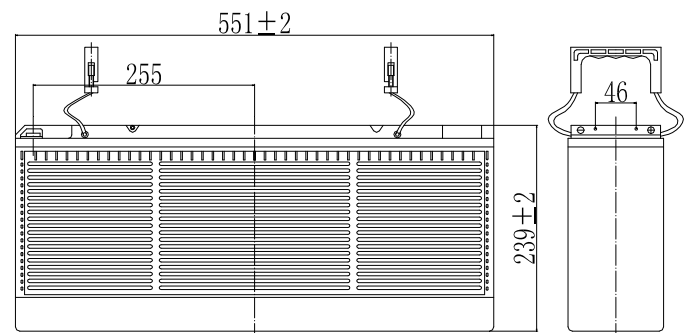

Terminal

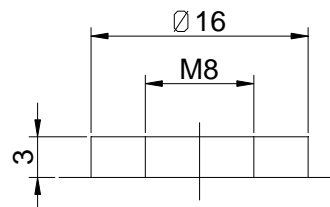

Terminal T11

LFP12120FT(12V120Ah)

Discharge Characteristics(25°C)

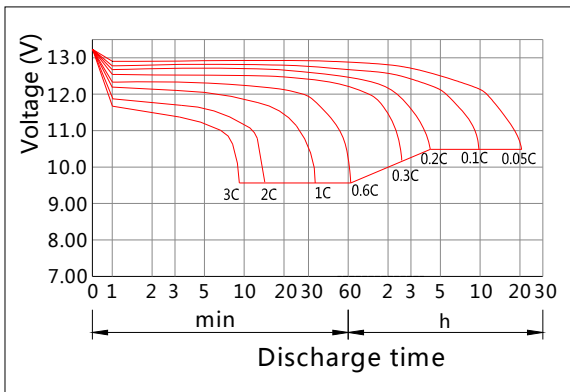

Charging Characteristics(25°C)

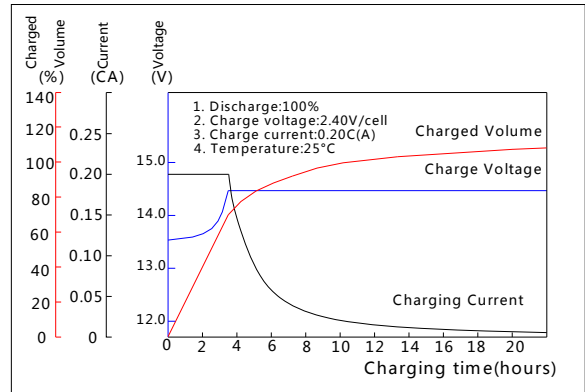

Effect of Temperature on Capacity

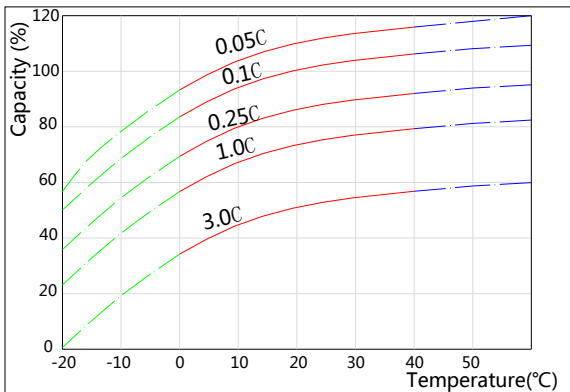

Self-discharge Characteristics

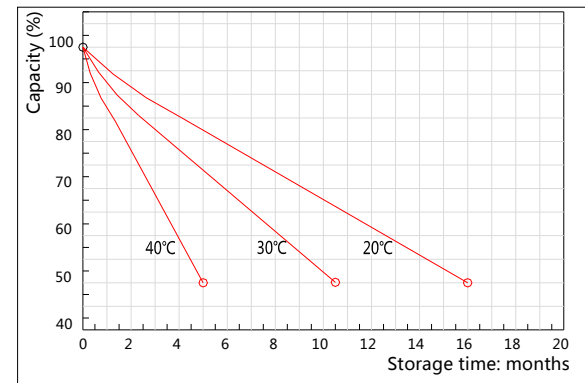

The Relationship for Open Circuit Voltage and Residual Capacity (25°C)

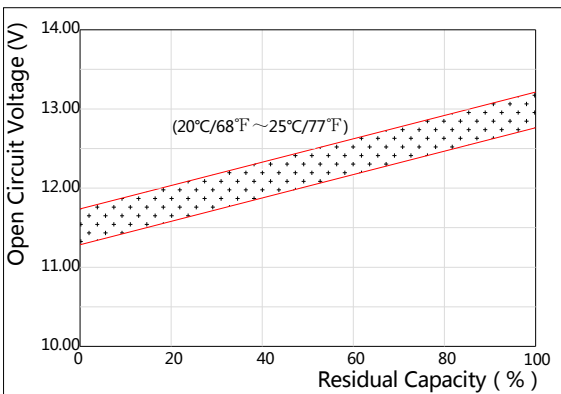

The Relationship for Charging Voltage and Temperature

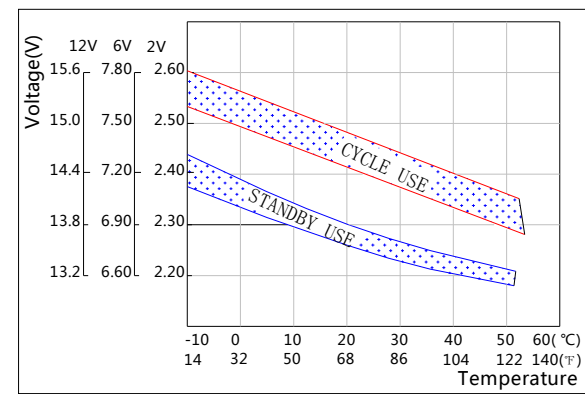

Floating Life on Temperature

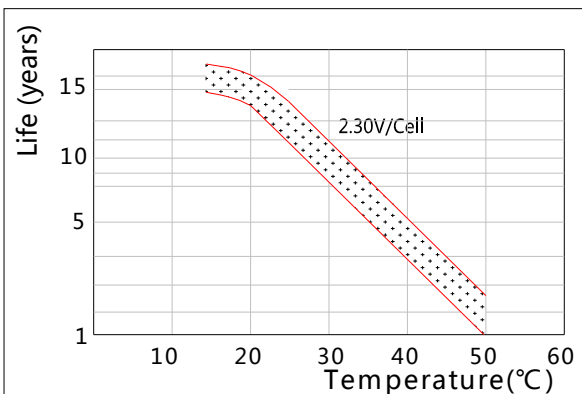

Cycle Life on D.O.D(25°C)

