

LFP12170FT(12V170Ah)

Specifications

Nominal Voltage		12 V
Capacity (25°C)	10HR(10.8V)	170 Ah
	5HR(10.5V)	149Ah
	1HR(9.60V)	105Ah
Dimension	Length	546 ± 3mm (21.50inch)
	Width	125 ± 2mm (4.92inch)
	Height	317 ± 2mm (12.48inch)
	Total Height	323 ± 2mm (12.72inch)
Approx. Weight		54kg (119.1lbs) ± 4%
Terminal type		T11
Internal resistance (Fully charged, 25°C)		Approx. 4mΩ
Capacity affected by temperature (10HR)	40°C	102%
	25°C	100%
	0°C	85%
	-15°C	65%
Self-discharge (25°C)	3 month	Remaining Capacity: 91%
	6 month	Remaining Capacity: 82%
	12 month	Remaining Capacity: 65%
Nominal operating temperature		25°C ± 3°C (77°F ± 5°F)
Operating temperature range	Discharge	-15°C ~ 50°C (5°F ~ 122°F)
	Charge	-10°C ~ 50°C (14°F ~ 122°F)
	Storage	-20°C ~ 50°C (-4°F ~ 122°F)
Float charging voltage(25°C)		13.50 to 13.80V Temperature compensation: -18mV/°C
Cyclic charging voltage(25°C)		14.50 to 14.90V Temperature compensation: -30mV/°C
Maximum charging current		51A
Terminal material		Copper
Maximum discharge current		1250A(5 sec.)
Designed floating life(20°C)		15 years

- ◆ Absorbent glass mat technology;
- ◆ Recognized by UL & CE;
- ◆ ABS container.

Constant Current Discharge Characteristics (A, 25°C)

F.V/TIME	15min	30min	60min	2h	3h	4h	5h	6h	8h	10h	20h
9.60V	275	167	105	62.1	43.4	35.5	30.3	26.5	20.8	17.3	9.09
9.90V	268	163	104	61.8	43.1	35.3	30.2	26.4	20.7	17.3	9.07
10.2V	258	158	101	61.2	42.8	35.1	30.0	26.2	20.5	17.2	9.04
10.5V	250	154	99.2	60.3	42.5	34.9	29.8	26.0	20.4	17.1	8.99
10.8V	236	149	96.1	58.8	41.2	33.8	28.9	25.2	19.8	17.0	8.93

Constant Power Discharge Characteristics (Watt, 25°C)

F.V/TIME	15min	30min	60min	2h	3h	4h	5h	6h	8h	10h	20h
9.60V	3018	1869	1202	719	510	418	359	314	247	207	109
9.90V	2946	1832	1184	715	507	416	357	312	246	206	109
10.2V	2837	1776	1153	709	503	413	354	310	244	206	108
10.5V	2741	1733	1131	698	500	410	352	307	242	204	108
10.8V	2596	1669	1096	680	485	398	341	298	235	203	107

Note: The above characteristics data can be obtained within three charge/discharge cycles.

Dimensions

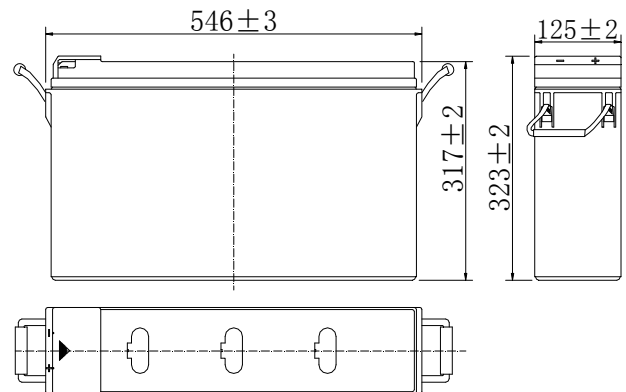

Terminal

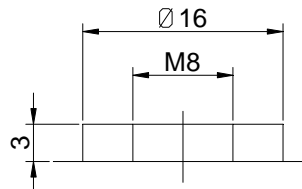

Terminal T11

LFP12170FT(12V170Ah)

Discharge Characteristics(25°C)

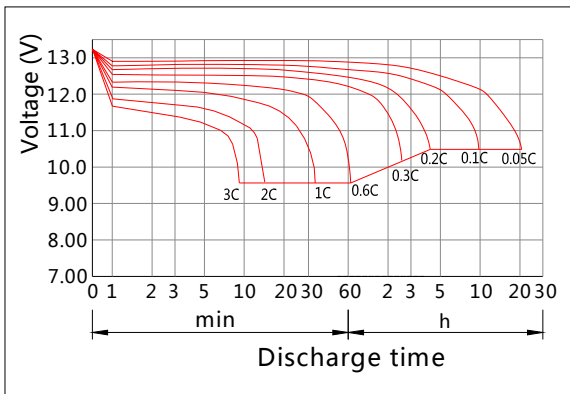

Charging Characteristics(25°C)

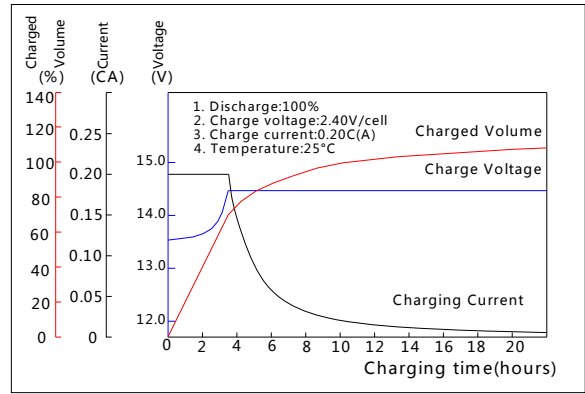

Effect of Temperature on Capacity

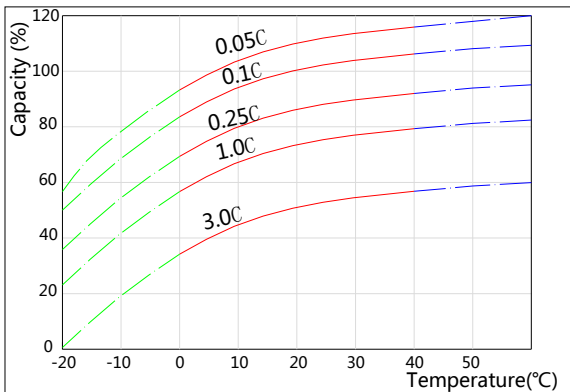

Self-discharge Characteristics

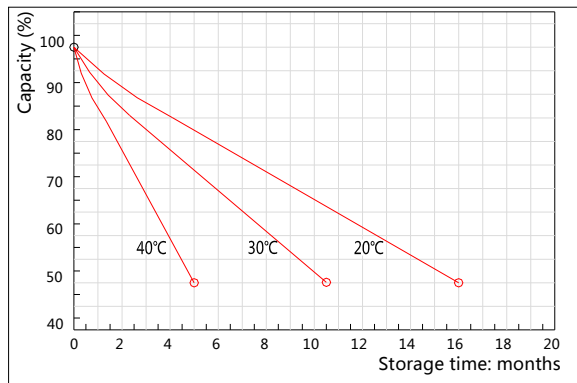

The Relationship for Open Circuit Voltage and Residual Capacity (25°C)

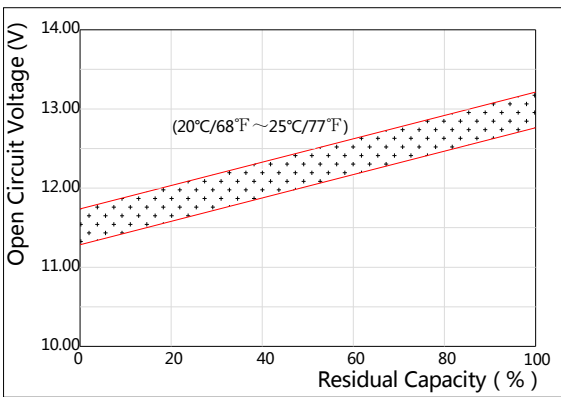

The Relationship for Charging Voltage and Temperature

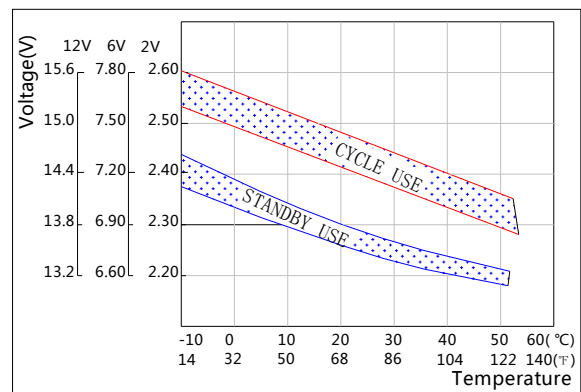

Floating Life on Temperature

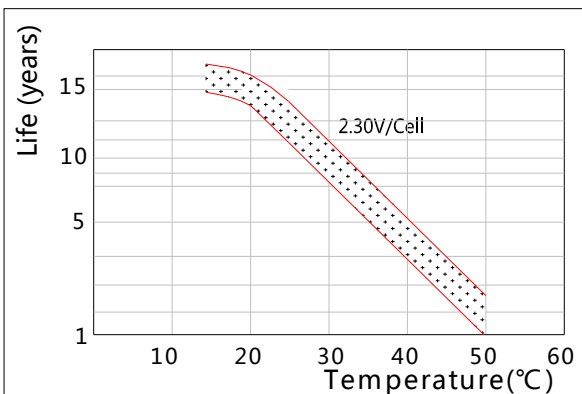

Cycle Life on D.O.D(25°C)

