

LFP12180(12V180Ah)

Specifications

Nominal Voltage		12 V
Capacity (25°C)	10HR(10.8V)	180 Ah
	5HR(10.5V)	157.5Ah
	1HR(9.60V)	112Ah
Dimension	Length	494 ± 2mm (19.45inch)
	Width	206 ± 2mm (8.11inch)
	Height	209 ± 2mm (8.23inch)
	Total Height	235 ± 2mm (9.25inch)
Approx. Weight		54kg (119.1lbs) ± 4%
Terminal type		T20/T11
Internal resistance (Fully charged, 25°C)		Approx. 3.3m Ω
Capacity affected by temperature (10HR)	40°C	102%
	25°C	100%
	0°C	85%
	-15°C	65%
Self-discharge (25°C)	3 month	Remaining Capacity: 91%
	6 month	Remaining Capacity: 82%
	12 month	Remaining Capacity: 65%
Nominal operating temperature		25°C ± 3°C (77°F ± 5°F)
Operating temperature range	Discharge	-15°C ~ 50°C (5°F ~ 122°F)
	Charge	-10°C ~ 50°C (14°F ~ 122°F)
	Storage	-20°C ~ 50°C (-4°F ~ 122°F)
Float charging voltage(25°C)		13.50 to 13.80V Temperature compensation: -18mV/°C
Cyclic charging voltage(25°C)		14.50 to 14.90V Temperature compensation: -30mV/°C
Maximum charging current		54A
Terminal material		T20: Lead, T11: Copper
Maximum discharge current		1400A(5 sec.)
Designed floating life(20°C)		12 years

- ◆ Absorbent glass mat technology;
- ◆ Recognized by UL & CE;
- ◆ ABS container.

Constant Current Discharge Characteristics (A, 25°C)

F.V/TIME	10min	15min	30min	60min	2h	3h	4h	5h	6h	8h	10h	20h
9.60V	354	297	180	112	65.8	45.9	37.6	32.1	28.1	22.0	18.3	9.62
9.90V	344	290	176	110	65.4	45.6	37.4	31.9	27.9	21.9	18.3	9.60
10.2V	330	279	171	107	64.8	45.3	37.2	31.7	27.7	21.8	18.2	9.57
10.5V	315	270	167	105	63.8	45.0	36.9	31.5	27.5	21.6	18.1	9.52
10.8V	298	255	161	102	62.2	43.7	35.8	30.6	26.7	21.0	18.0	9.45

Constant Power Discharge Characteristics (Watt, 25°C)

F.V/TIME	10min	15min	30min	60min	2h	3h	4h	5h	6h	8h	10h	20h
9.60V	3828	3261	2020	1272	762	540	443	380	332	262	219	115
9.90V	3713	3183	1979	1253	757	537	440	378	330	260	218	115
10.2V	3560	3065	1919	1221	750	533	437	375	328	258	218	115
10.5V	3407	2961	1872	1197	739	529	434	372	326	257	216	114
10.8V	3215	2805	1804	1160	720	513	421	361	316	249	215	113

Note: The above characteristics data can be obtained within three charge/discharge cycles.



Dimensions

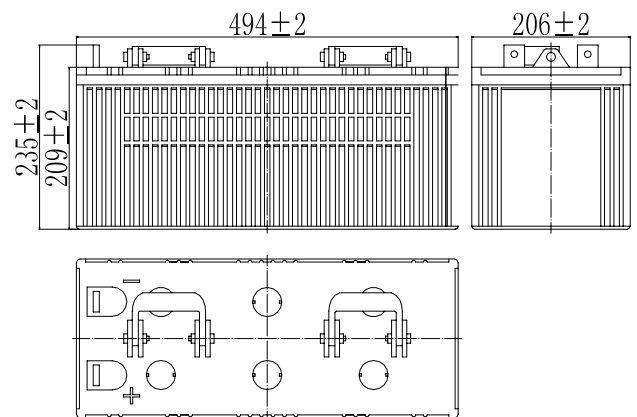

Terminal

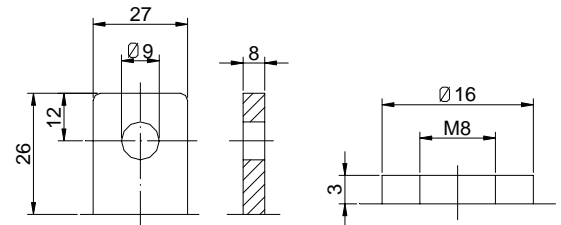

Terminal T20

Terminal T11

LFP12180(12V180Ah)

Discharge Characteristics(25°C)

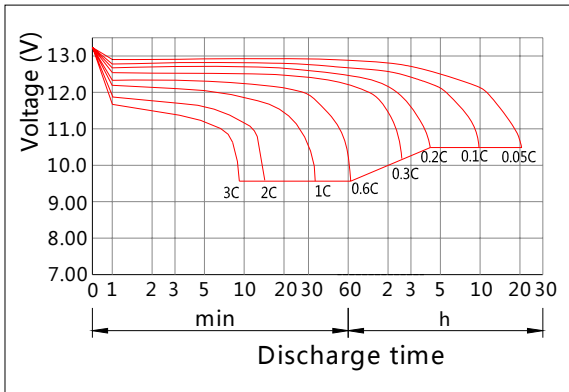

Charging Characteristics(25°C)

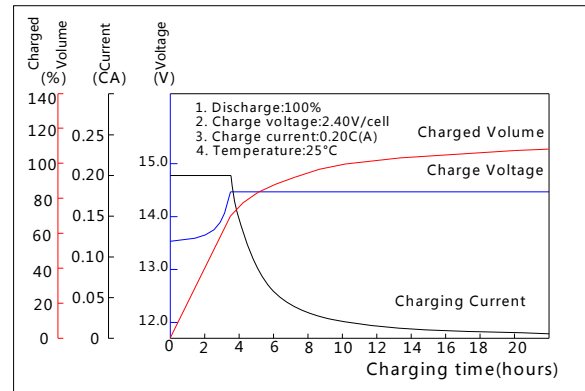

Effect of Temperature on Capacity

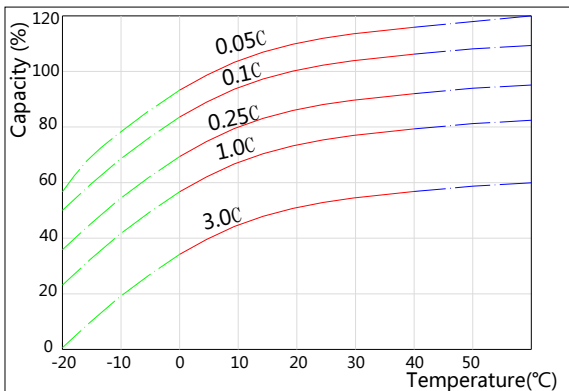

Self-discharge Characteristics

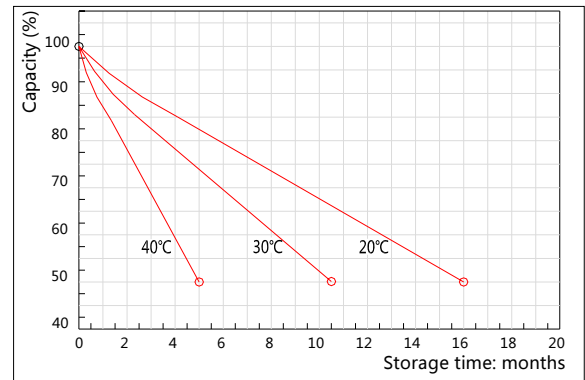

The Relationship for Open Circuit Voltage and Residual Capacity (25°C)

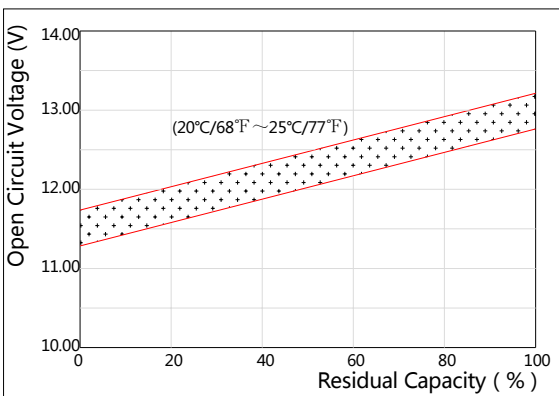

The Relationship for Charging Voltage and Temperature

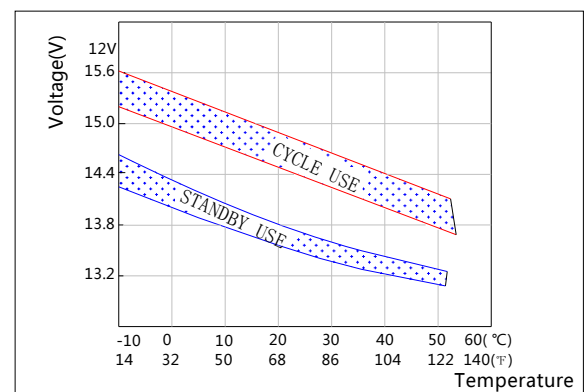

Floating Life on Temperature

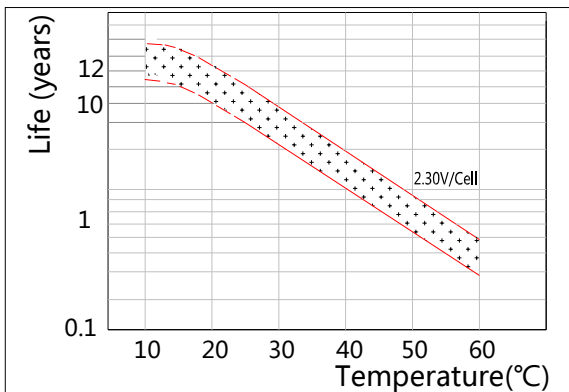

Cycle Life on D.O.D(25°C)

