

LFP12134(12V134Ah)

Specifications

Nominal Voltage		12 V
Capacity (25°C)	10HR(10.8V)	134 Ah
	5HR(10.5V)	117.5Ah
	1HR(9.60V)	83.1Ah
Dimension	Length	342 ± 2mm (13.46inch)
	Width	172 ± 2mm (6.77inch)
	Height	280 ± 2mm (11.02inch)
	Total Height	285 ± 2mm (11.22inch)
Approx. Weight		41.4kg (90.9lbs) ± 4%
Terminal type		T11
Internal resistance (Fully charged, 25°C)		Approx. 3.8m Ω
Capacity affected by temperature (10HR)	40°C	102%
	25°C	100%
	0°C	85%
	-15°C	65%
Self-discharge (25°C)	3 month	Remaining Capacity: 91%
	6 month	Remaining Capacity: 82%
	12 month	Remaining Capacity: 65%
Nominal operating temperature		25°C ± 3°C (77°F ± 5°F)
Operating temperature range	Discharge	-15°C ~ 50°C (5°F ~ 122°F)
	Charge	-10°C ~ 50°C (14°F ~ 122°F)
	Storage	-20°C ~ 50°C (-4°F ~ 122°F)
Float charging voltage(25°C)		13.50 to 13.80V Temperature compensation: -18mV/°C
Cyclic charging voltage(25°C)		14.50 to 14.90V Temperature compensation: -30mV/°C
Maximum charging current		40.2A
Terminal material		Copper
Maximum discharge current		1050A(5 sec.)
Designed floating life(20°C)		12 years

- ◆ Absorbent glass mat technology;
- ◆ Recognized by UL & CE;
- ◆ ABS container.

Constant Current Discharge Characteristics (A, 25°C)

F.V/TIME	15min	30min	60min	2h	3h	4h	5h	6h	8h	10h	20h
9.60V	221	134	83.1	49.0	34.2	28.0	23.9	20.9	16.4	13.6	7.16
9.90V	216	131	81.8	48.7	34.0	27.9	23.8	20.8	16.3	13.6	7.15
10.2V	208	127	79.8	48.2	33.7	27.7	23.6	20.6	16.2	13.6	7.13
10.5V	201	124	78.2	47.5	33.5	27.5	23.5	20.5	16.1	13.5	7.08
10.8V	190	120	75.8	46.3	32.5	26.6	22.7	19.9	15.6	13.4	7.04

Constant Power Discharge Characteristics (Watt, 25°C)

F.V/TIME	15min	30min	60min	2h	3h	4h	5h	6h	8h	10h	20h
9.60V	2428	1503	947	567	402	330	283	247	195	163	85.9
9.90V	2369	1473	933	564	399	328	281	246	194	163	85.8
10.2V	2282	1428	909	559	397	325	279	244	192	162	85.5
10.5V	2204	1394	891	550	394	323	277	242	191	161	85.0
10.8V	2088	1343	864	536	382	313	269	235	185	160	84.4

Note: The above characteristics data can be obtained within three charge/discharge cycles.



Dimensions

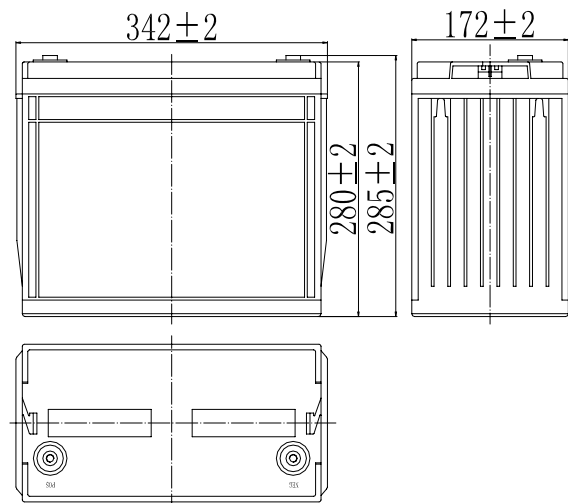

Terminal

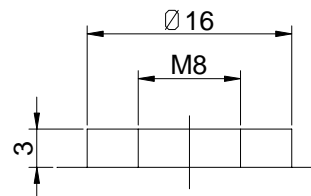

Terminal T11

LFP12134(12V134Ah)

Discharge Characteristics(25°C)

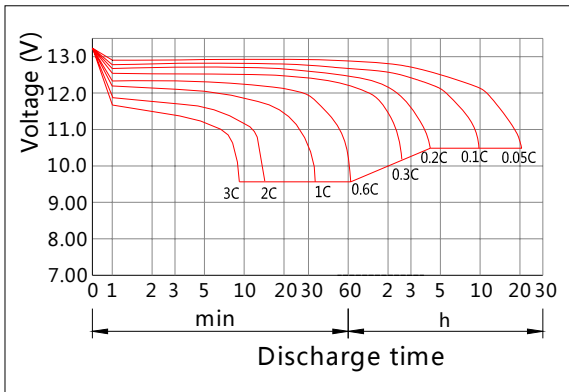

Charging Characteristics(25°C)

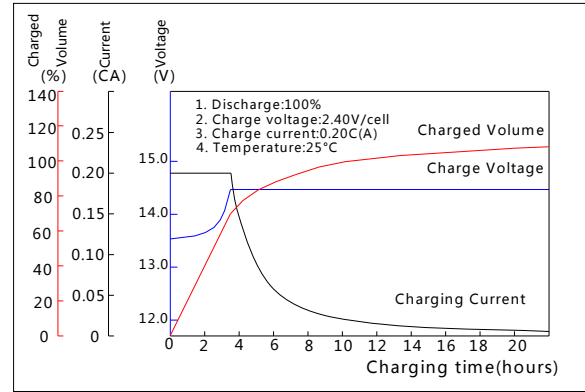

Effect of Temperature on Capacity

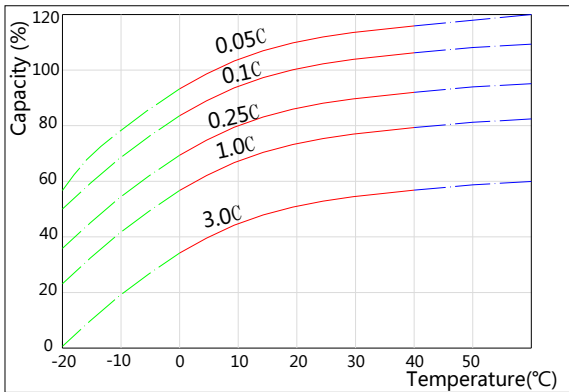

Self-discharge Characteristics

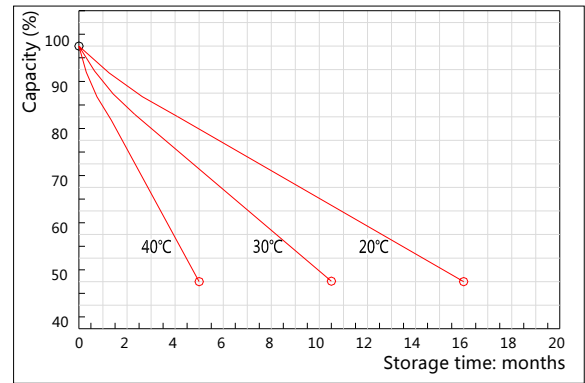

The Relationship for Open Circuit Voltage and Residual Capacity (25°C)

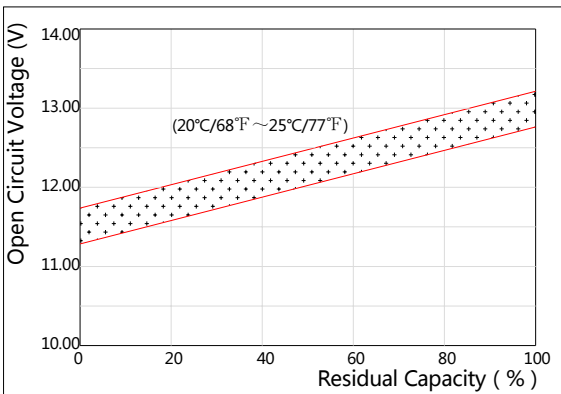

The Relationship for Charging Voltage and Temperature

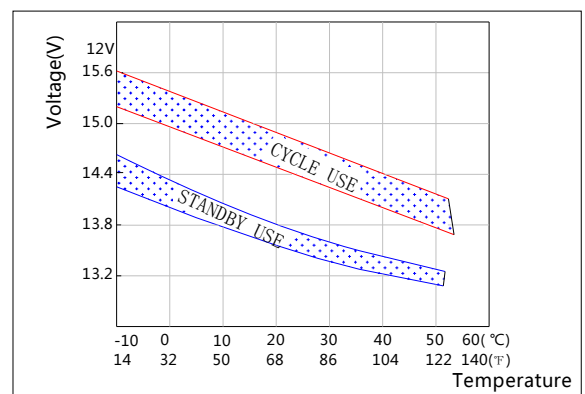

Floating Life on Temperature

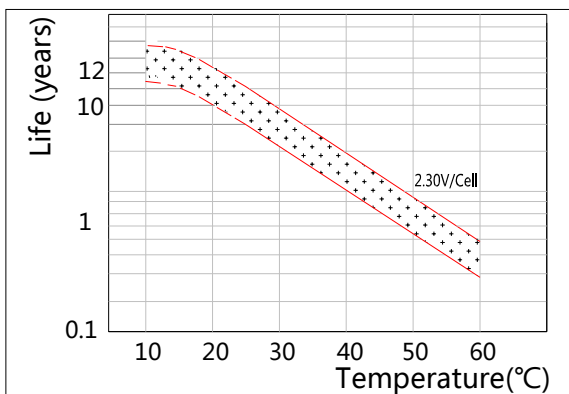

Cycle Life on D.O.D(25°C)

