

Specifications

Nominal Voltage		12 V
Capacity (25°C)	20HR(10.5V)	0.8Ah
	10HR(10.5V)	0.74Ah
	1HR(9.60V)	0.52Ah
Dimension	Length	96 ± 1mm (3.78inch)
	Width	25 ± 0.5mm (0.98inch)
	Height	62 ± 1mm (2.44inch)
	Total Height	62 ± 1mm (2.44inch)
Approx. Weight		0.33kg (0.73lbs) ± 5%
Terminal type		Plug
Internal resistance (Fully charged, 25°C)		Approx. 200m Ω
Capacity affected by temperature (20HR)	40°C	102%
	25°C	100%
	0°C	85%
	-15°C	65%
Self-discharge (25°C)	3 month	Remaining Capacity: 91%
	6 month	Remaining Capacity: 82%
	12 month	Remaining Capacity: 65%
Nominal operating temperature		25°C ± 3°C (77°F ± 5°F)
Operating temperature range	Discharge	-15°C ~ 50°C (5°F ~ 122°F)
	Charge	-10°C ~ 50°C (14°F ~ 122°F)
	Storage	-20°C ~ 50°C (-4°F ~ 122°F)
Float charging voltage(25°C)		13.60 to 13.80V Temperature compensation: -18mV/°C
Cyclic charging voltage(25°C)		14.50 to 14.90V Temperature compensation: -30mV/°C
Maximum charging current		0.24A
Terminal material		Wire Plug
Maximum discharge current		5A(5 sec.)
Designed floating life(20°C)		10years

- ◆ Absorbent glass mat technology;
- ◆ Recognized by UL & CE;
- ◆ ABS container.

Constant Current Discharge Characteristics (A, 25°C)

F.V/TIME	10min	15min	30min	60min	2h	3h	4h	5h	8h	10h	20h
9.60V	1.92	1.52	0.85	0.52	0.284	0.204	0.163	0.139	0.090	0.076	0.041
9.90V	1.86	1.48	0.83	0.51	0.283	0.203	0.162	0.138	0.089	0.075	0.040
10.2V	1.79	1.43	0.81	0.50	0.280	0.201	0.161	0.137	0.089	0.075	0.040
10.5V	1.71	1.38	0.79	0.49	0.276	0.200	0.160	0.136	0.088	0.074	0.040
10.8V	1.61	1.31	0.76	0.47	0.269	0.194	0.155	0.132	0.085	0.073	0.039

Constant Power Discharge Characteristics (Watt, 25°C)

F.V/TIME	10min	15min	30min	60min	2h	3h	4h	5h	8h	10h	20h
9.60V	21.7	17.3	9.7	6.0	3.33	2.42	1.94	1.66	1.08	0.91	0.49
9.90V	21.0	16.9	9.5	5.9	3.31	2.41	1.93	1.65	1.07	0.90	0.49
10.2V	20.1	16.3	9.2	5.8	3.28	2.39	1.92	1.64	1.06	0.90	0.48
10.5V	19.3	15.7	9.0	5.7	3.23	2.38	1.91	1.62	1.06	0.89	0.48
10.8V	18.2	14.9	8.7	5.5	3.14	2.30	1.85	1.58	1.02	0.87	0.47

Note: The above characteristics data can be obtained within three charge/discharge cycles.

Dimensions

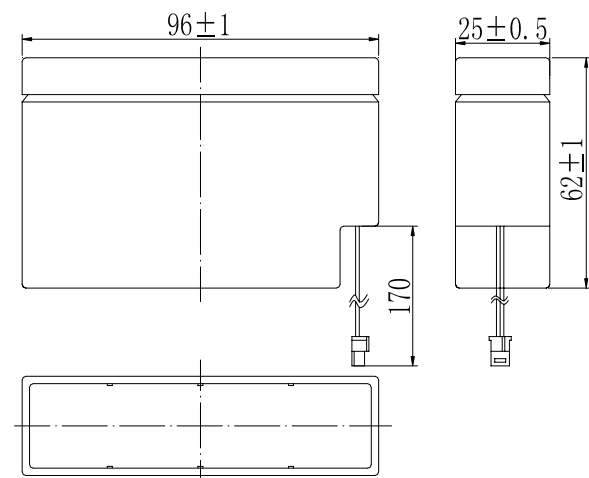

Terminal

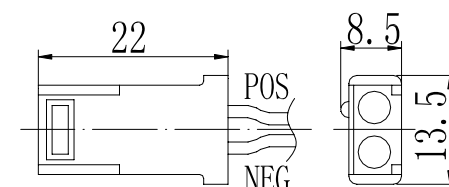

Terminal: AMP

Discharge Characteristics(25°C)

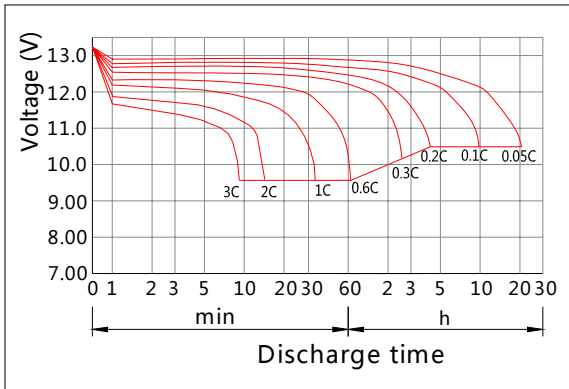

Charging Characteristics(25°C)

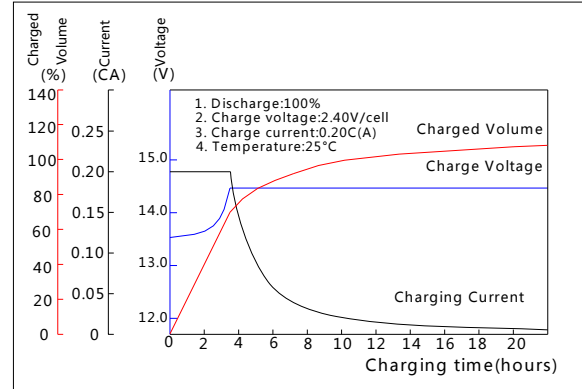

Effect of Temperature on Capacity

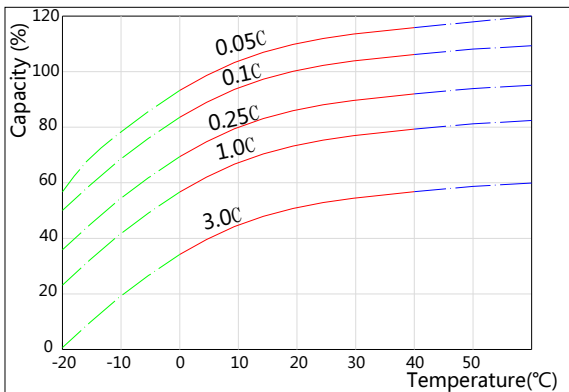

Self-discharge Characteristics

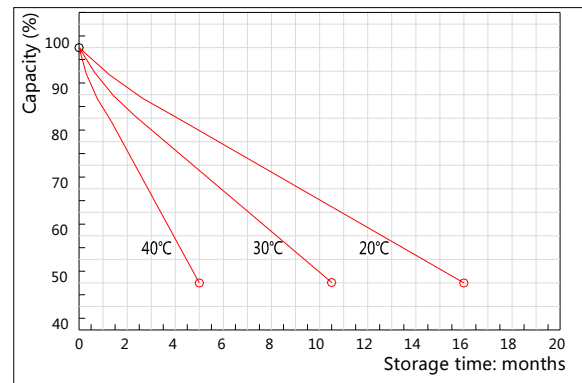

The Relationship for Open Circuit Voltage and Residual Capacity (25°C)

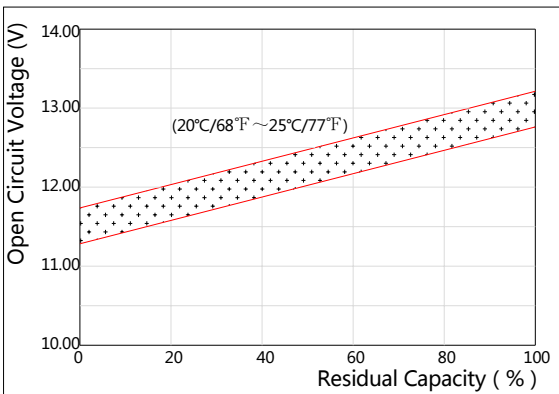

The Relationship for Charging Voltage and Temperature

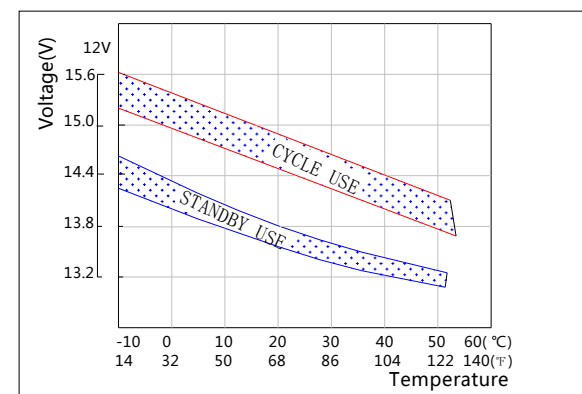

Floating Life on Temperature

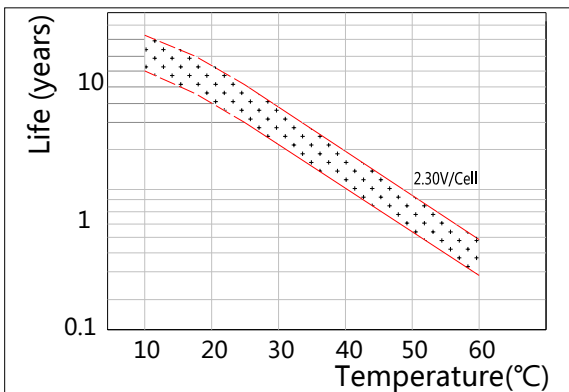

Cycle Life on D.O.D(25°C)

