

Specifications

Nominal Voltage		6 V
Capacity (25°C)	20HR(5.25V)	4Ah
	10HR(5.25V)	3.7Ah
	1HR(4.80V)	2.6Ah
Dimension	Length	70 ± 1mm (2.76inch)
	Width	47 ± 1mm (1.85inch)
	Height	101 ± 1mm (3.98inch)
	Total Height	107 ± 1mm (4.21inch)
Approx. Weight		0.68kg (1.50lbs) ± 5%
Terminal type		T1
Internal resistance (Fully charged, 25°C)		Approx. 30mΩ
Capacity affected by temperature (20HR)	40°C	102%
	25°C	100%
	0°C	85%
	-15°C	65%
Self-discharge (25°C)	3 month	Remaining Capacity: 91%
	6 month	Remaining Capacity: 82%
	12 month	Remaining Capacity: 65%
Nominal operating temperature		25°C ± 3°C (77°F ± 5°F)
Operating temperature range	Discharge	-15°C ~ 50°C (5°F ~ 122°F)
	Charge	-10°C ~ 50°C (14°F ~ 122°F)
	Storage	-20°C ~ 50°C (-4°F ~ 122°F)
Float charging voltage(25°C)	6.80 to 6.90V Temperature compensation: -9mV/°C	
Cyclic charging voltage(25°C)	7.25 to 7.45V Temperature compensation: -15mV/°C	
Maximum charging current	1.2A	
Terminal material	Copper	
Maximum discharge current	60A(5 sec.)	
Designed floating life(20°C)	10years	

- ◆ Absorbent glass mat technology;
- ◆ Recognized by UL & CE;
- ◆ ABS container.

Dimensions

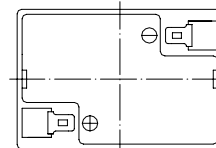
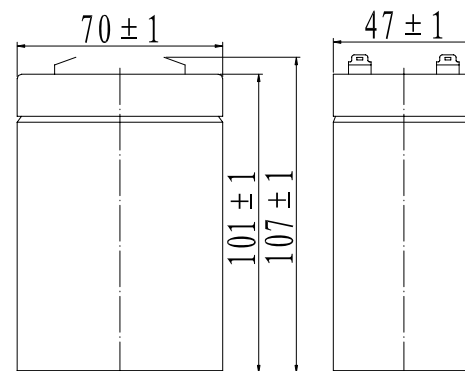

Terminal

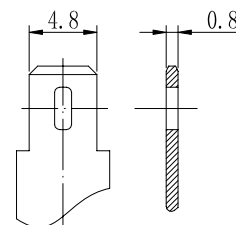

Terminal T1

Constant Current Discharge Characteristics (A, 25°C)

F.V/TIME	5min	10min	15min	30min	60min	2h	3h	4h	5h	10h	20h
4.80V	15.2	9.60	7.60	4.24	2.60	1.42	1.02	0.82	0.69	0.38	0.21
4.95V	14.7	9.31	7.42	4.16	2.56	1.41	1.01	0.81	0.69	0.38	0.20
5.10V	14.1	8.93	7.14	4.03	2.50	1.40	1.01	0.81	0.68	0.37	0.20
5.25V	13.5	8.54	6.90	3.93	2.45	1.38	1.00	0.80	0.68	0.37	0.20
5.40V	12.8	8.06	6.54	3.79	2.37	1.34	0.97	0.78	0.66	0.36	0.20

Constant Power Discharge Characteristics (Watt, 25°C)

F.V/TIME	5min	10min	15min	30min	60min	2h	3h	4h	5h	10h	20h
4.80V	84.8	54.1	43.3	24.3	15.1	8.31	6.06	4.86	4.14	2.27	1.22
4.95V	82.3	52.5	42.3	23.8	14.8	8.26	6.02	4.83	4.12	2.26	1.21
5.10V	78.9	50.4	40.7	23.1	14.5	8.19	5.98	4.80	4.09	2.25	1.21
5.25V	75.5	48.2	39.3	22.5	14.2	8.07	5.94	4.76	4.06	2.23	1.20
5.40V	71.2	45.5	37.3	21.7	13.7	7.86	5.76	4.62	3.94	2.19	1.18

Note: The above characteristics data can be obtained within three charge/discharge cycles.

Discharge Characteristics(25°C)

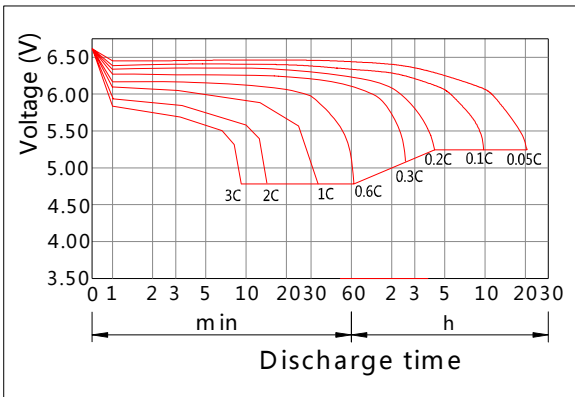

Charging Characteristics(25°C)

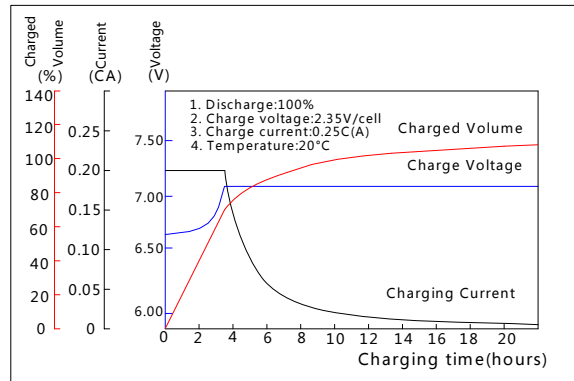

Effect of Temperature on Capacity

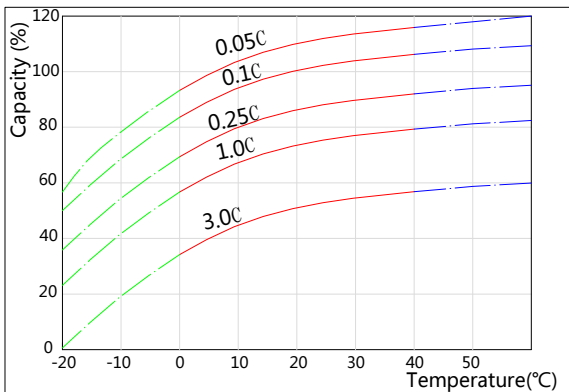

Self-discharge Characteristics

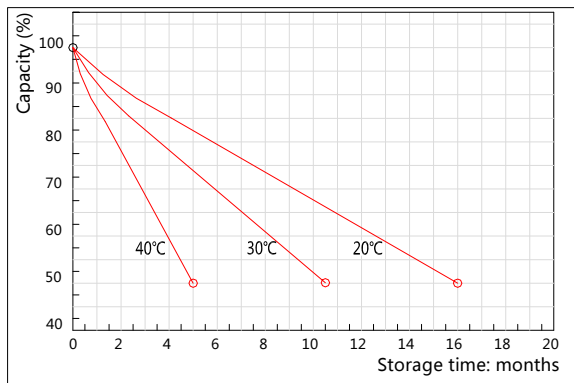

The Relationship for Open Circuit Voltage and Residual Capacity (25°C)

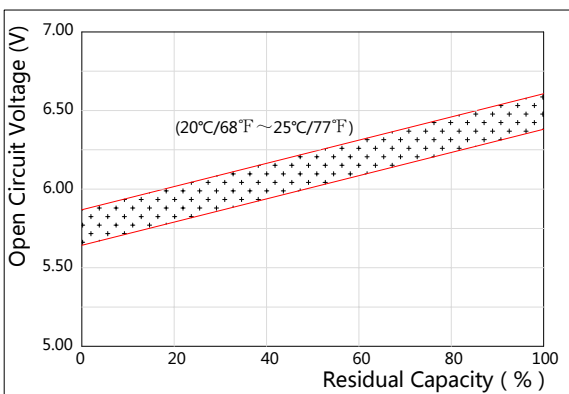

The Relationship for Charging Voltage and Temperature

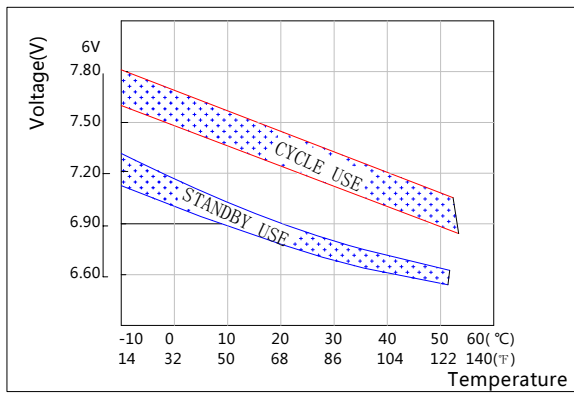

Floating Life on Temperature

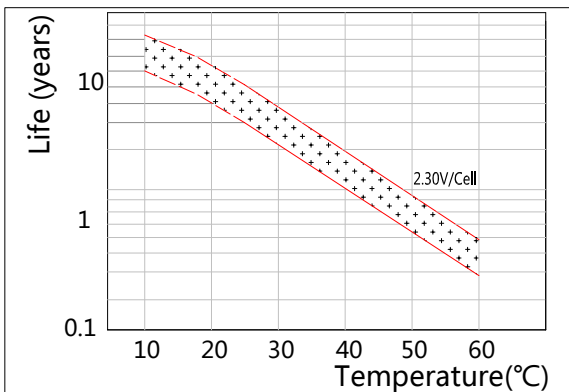

Cycle Life on D.O.D(25°C)

